

Technical Application Papers No.10

Photovoltaic plants

Photovoltaic plants

Index

Introduction	4	3 Installation methods and configurations	26
1 Generalities on photovoltaic (PV) plants	5	3.1 Architectural integration	26
1.1 Operating principle	5	3.2 PV plant layout	27
1.2 Energy from the Sun	5	3.2.1 Single-inverter plant	27
1.3 Main components of a photovoltaic plant	8	3.2.2 Plant with one inverter for each string.....	27
1.3.1 Photovoltaic generator	8	3.2.3 Multi-inverter plant	27
1.3.2 Inverter.....	11	3.3 Selection and interfacing of inverters.....	28
1.4 Types of photovoltaic modules	12	3.4 Choice of cables	32
1.4.1 Crystal silicon modules	12	3.4.1 Types of cables	32
1.4.2 Thin-film modules	13	3.4.2 Cross-sectional area and current carrying capacity ...	33
1.5 Types of photovoltaic plants	15	4 Protection against overcurrents and overvoltages	34
1.5.1 Off-grid plants	15	4.1 Protection against overcurrents	
1.5.2 Grid-connected plants.....	16	on DC side	34
1.6 Intermittence of generation and storage of produced power.....	17	4.1.1 Cable protections	34
2 Energy production	18	4.1.2 Protection of strings against reverse current	35
2.1 Circuit equivalent to the cell.....	18	4.1.3 Contribution of the inverter	35
2.2 Voltage-current characteristic of the module	18	4.1.4 Choice of protective devices.....	35
2.3 Grid connection scheme	19	4.2 Protection against overcurrents on AC side. .	36
2.4 Nominal peak power	20	4.3 Choice of switching and disconnecting devices	37
2.5 Expected energy production per year....	20	4.4 Selection of surge protective devices (SPD) for the protection of PV plants against lightning	37
2.6 Inclination and orientation of the modules.....	22	4.4.1 PV plants on roofs.....	38
2.7 Voltages and currents in a PV plant.....	24	4.4.2 PV plants on ground.....	39
2.8 Variation in the produced energy	24	5 Earthing and protection against indirect contact	41
2.8.1 Irradiance.....	24	5.1 Earthing	41
2.8.2 Temperature of the modules	25		
2.8.3 Shading	25		

Photovoltaic plants

Index

5.2	Plants with transformer	41	6.1.15	Molded-case circuit-breakers for applications up to 1000 V DC	60
5.2.1	Exposed conductive parts on the load side of the transformer	41	6.1.16	Tmax PV molded-case circuit-breakers for direct current applications	61
5.2.1.1	Plant with IT system	41	6.1.17	Air circuit-breakers for direct current applications	62
5.2.1.2	Plant with TN system.....	41	6.1.18	Air switch-disconnectors for applications up to 1000V DC.....	66
5.2.2	Exposed conductive parts on the supply side of the transformer	42	6.1.19	New air switch-disconnectors for applications up to 1000V DC	67
5.3	Plants without transformer	43	6.2	Residual current releases Type B.....	68
6	ABB solutions for photovoltaic applications	44	6.2.1	Residual current releases RC223 and RC Type B...	68
6.1	Molded-case and air circuit-breakers	44	6.2.2	Residual Current Circuit-breakers (RCCBs).....	69
6.1.1	New series of molded-case circuit-breakers SACE Tmax XT	44	6.3	Contactors (for DC switching)	70
6.1.2	Tmax T molded-case circuit-breakers for alternating current applications	45	6.4	Switch-disconnectors	71
6.1.3	Molded-case circuit-breakers for applications up to 1150V AC	47	6.5	Miniature circuit-breakers	75
6.1.4	Molded-case switch-disconnectors Tmax T and SACE Tmax XT	50	6.6	String monitoring	76
6.1.5	Air circuit-breakers for alternating current applications.....	51	6.7	Surge protective devices.....	77
6.1.6	New automatic circuit-breakers for alternating current.....	52	6.8	Fuse disconnectors	79
6.1.7	Air circuit-breakers for applications up to 1150V AC.....	53	6.9	Cylindrical Fuses	79
6.1.8	New air circuit-breakers for applications up to 1150V AC.....	54	6.10	Remote command devices	80
6.1.9	Air switch-disconnectors.....	55	6.11	Insulation monitoring devices.....	81
6.1.10	New air switch-disconnectors.....	56	6.12	Monitoring relay - CEI 0-21 standard.....	83
6.1.11	Air switch-disconnectors for applications up to 1150V AC.....	57	6.13	Power buffers	84
6.1.12	New air switch-disconnectors for applications up to 1150V AC.....	58	6.14	Modular energy meters	85
6.1.13	Tmax T molded-case circuit-breakers for direct current applications	59	6.15	Switchboards	87
6.1.14	SACE Tmax XT molded-case circuit-breakers for direct current applications	60	6.16	Wall mounting consumer units.....	87
			6.17	Junction boxes.....	88

6.18 Cable glands and nuts with metric pitch.....	88	B.7 Solar thermal power	105
6.19 Screw clamp terminal blocks.....	88	B.8 Solar thermodynamic power	107
6.20 Polyamide 6.6 and 12 cable ties - UV resistant black.....	89	B.9 Hybrid systems.....	109
6.21 PMA Cable Protection System Solutions.....	90	Annex C – Dimensioning examples of photovoltaic plants	
6.22 Direct lightning protection.....	90	C.1 Introduction	110
6.23 Switchboards for string control and monitoring system for large networks.....	91	C.2 3kWp PV plant	110
6.24 Pre-wired interface switchboards	92	C.3 60kWp PV plant	113
6.25 DC string boxes.	92	Annex D – Temperature rise, MCB and disconnecter behavior in photovoltaic applications.....	118
6.26 CPI DC string boxes.....	95		
6.27 Multi-output DC string boxes.....	98		

Annex A – New technologies

A.1 Cells: emerging technologies.....	99
A.2 Concentrating photovoltaics.....	100
A.3 PV systems with cylindrical modules	101
A.4 Floating PV systems.....	101
A.5 Micro-inverters	102

Annex B – Other renewable energy sources

B.1 Introduction.....	103
B.2 Wind power.....	103
B.3 Biomass energy source	103
B.4 Geothermal power	104
B.5 Tidal power and wave motion.....	104
B.6 Mini-hydroelectric power.....	105

Introduction

In the present global energy and environmental context, the aim to reduce the emissions of greenhouse gases and polluting substances (also following the Kyoto protocol) has become of primary importance. This target can be reached also by exploiting alternative and renewable energy sources to back up and reduce the use of the fossil fuels, which moreover are doomed to run out because of the great consumption by several countries.

The Sun is certainly a high potential source for renewable energy and it is possible to turn to it in the full respect of the environment. Just think that instant by instant the surface of the terrestrial hemisphere exposed to the Sun gets a power exceeding 50 thousand TW; the quantity of solar energy which reaches the terrestrial soil is enormous, about 10 thousand times the energy used all over the world.

Among the different systems using renewable energy sources, photovoltaics is promising due to the intrinsic qualities of the system itself: it has very reduced service costs (fuel is free of charge) and limited maintenance requirements, it is reliable, noiseless and quite easy to install. Moreover, photovoltaics, in some grid-off applications, is definitely convenient in comparison with other energy sources, especially in those places which are difficult and uneconomic to reach with traditional electric lines.

This Technical Paper is aimed at analyzing the problems and the basic concepts to be faced when realizing a photovoltaic plant. Starting from a general description of the modalities of exploiting solar energy through PV plants, a short description is given of the methods of protection against overcurrents, overvoltages and indirect contact, so as to offer a guide to the proper selection of the operating and protection devices for the different components of the plant.

This new edition of the Technical Paper is divided into two parts: the first part, which is more general and includes the first five chapters, describes the operating principle of PV plants, their typology, the main components, the installation methods, the different configurations and the protection systems. Besides, it offers an analysis of the production of energy in a plant and illustrates how it varies as a function of determined quantities.

The second part (which includes Chapter 6) illustrates the ABB solutions for photovoltaic applications.

To complete this Technical Paper, there are four annexes which present:

- a description of the new technologies used in photovoltaic plants
- a description of the other renewable energy sources;
- an example for the dimensioning of a 3kWp PV plant for a detached house and of a 60kWp plant for an artisan manufacturing business.
- a description of temperature rise, MCB and disconnector behavior in photovoltaic applications.



1 Generalities on photovoltaic (PV) plants

1.1 Operating principle

A photovoltaic (PV) plant transforms directly and instantaneously solar energy into electrical energy without using any fuels. As a matter of fact, the photovoltaic (PV) technology exploits the effect through which some semiconductors suitably “doped” generate electricity when exposed to solar radiation.

The main advantages of photovoltaic (PV) plants can be summarized as follows:

- distributed generation where needed;
- zero emission of polluting materials;
- saving of fossil fuels;
- reliability of the plants since they do not have moving parts (useful life usually over 20 years);
- reduced operating and maintenance costs;
- system modularity (to increase the plant power it is sufficient to raise the number of modules) according to the real requirements of users.

However, the initial cost for the development of a PV plant is quite high due to a market which has not reached its full maturity from a technical and economical point of view. Moreover, the generation of power is erratic due to the variability of the solar energy source.

The annual electrical power output of a PV plant depends on different factors. Among them:

- solar radiation incident on the installation site;
- inclination and orientation of the modules;
- presence or not of shading;
- technical performances of the plant components (mainly modules and inverters).

The main applications of PV plants are:

1. installations (with storage systems) for off-grid loads;
2. installations for users connected to the LV grid;
3. solar PV power plants, usually connected to the MV grid.

Feed-in Tariff incentives are granted only for the applications of type 2 and 3, in plants with rated power not lower than 1 kW.

A PV plant is essentially constituted by a generator (PV modules), by a supporting frame to mount the modules on the ground, on a building or on any building structure, by a system for power control and conditioning, by a possible energy storage system, by electrical switchboards and switchgear assemblies housing the switching and protection equipment and by connection cables.

1.2 Energy from the Sun

Thermonuclear fusion reactions occur unceasingly in the core of the Sun at millions of degrees; they release huge quantities of energy in the form of electromagnetic radiations. A part of this energy reaches the outer part of the Earth’s atmosphere with an average irradiance (solar constant) of about $1,367 \text{ W/m}^2 \pm 3\%$, a value which varies as a function of the Earth-to-Sun distance (Figure 1.1) and of the solar activity (sunspots).

Figure 1.1 - Extra-atmospheric radiation

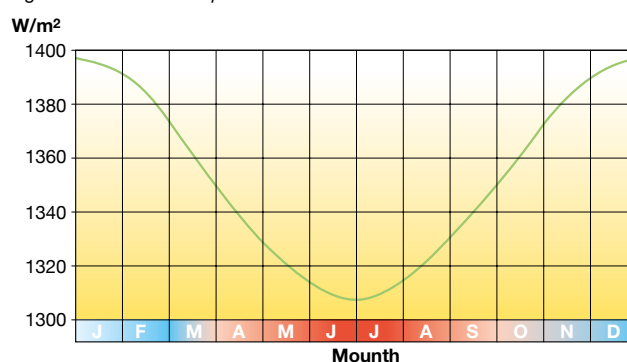

With *solar irradiance* we mean the intensity of the solar electromagnetic radiation incident on a surface of 1 square meter [kW/m^2]. Such intensity is equal to the integral of the power associated to each value of the frequency of the solar radiation spectrum.

When passing through the atmosphere, the solar radiation diminishes in intensity because it is partially reflected and absorbed (above all by the water vapor and by the other atmospheric gases). The radiation which passes through is partially diffused by the air and by the solid particles suspended in the air (Figure 1.2).

Figure 1.2 - Energy flow between the sun, the atmosphere and the ground

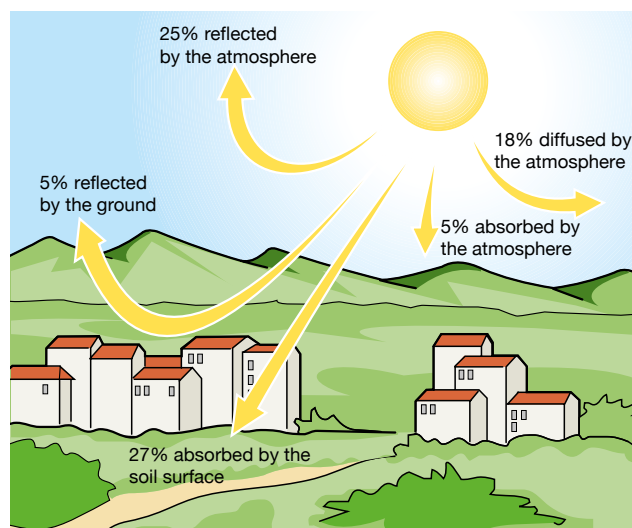

¹ Due to its elliptical orbit the Earth is at its least distance from the Sun (perihelion) in December and January and at its greatest distance (aphelion) in June and July.

With **solar radiation** we mean the integral of the solar irradiance over a specified period of time [kWh/m²]. Therefore the radiation falling on a horizontal surface is constituted by a direct radiation, associated to the direct irradiance on the surface, by a diffuse radiation which strikes the surface from the whole sky and not from a specific part of it and by a radiation reflected on a given surface by the ground and by the surrounding environment (Figure 1.3). In winter the sky is overcast and the diffuse component is greater than the direct one.

Figure 1.3 - Components of solar radiation

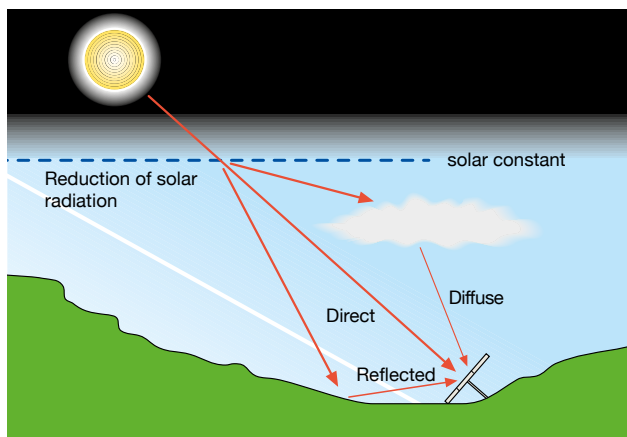

The reflected radiation depends on the capability of a surface to reflect the solar radiation and it is measured by the albedo coefficient calculated for each material (Figure 1.4).

Figure 1.4 - Reflected radiation

surface type	albedo
Dirty roads	0,04
Aqueous surfaces	0,07
Coniferous forest in winter	0,07
Worn asphalt	0,10
Bitumen roofs and terraces	0,13
Soil (clay, marl)	0,14
Dry grass	0,20
Rubble	0,20
Worn concrete	0,22
Forest in autumn / fields	0,26
Green grass	0,26
Dark surfaces of buildings	0,27
Dead leaves	0,30
Bright surfaces of buildings	0,60
Fresh snow	0,75

Figure 1.5 shows the world atlas of the average solar irradiance on an inclined plan 30° South [kWh/m²/day].

Figure 1.5 - Solar Atlas

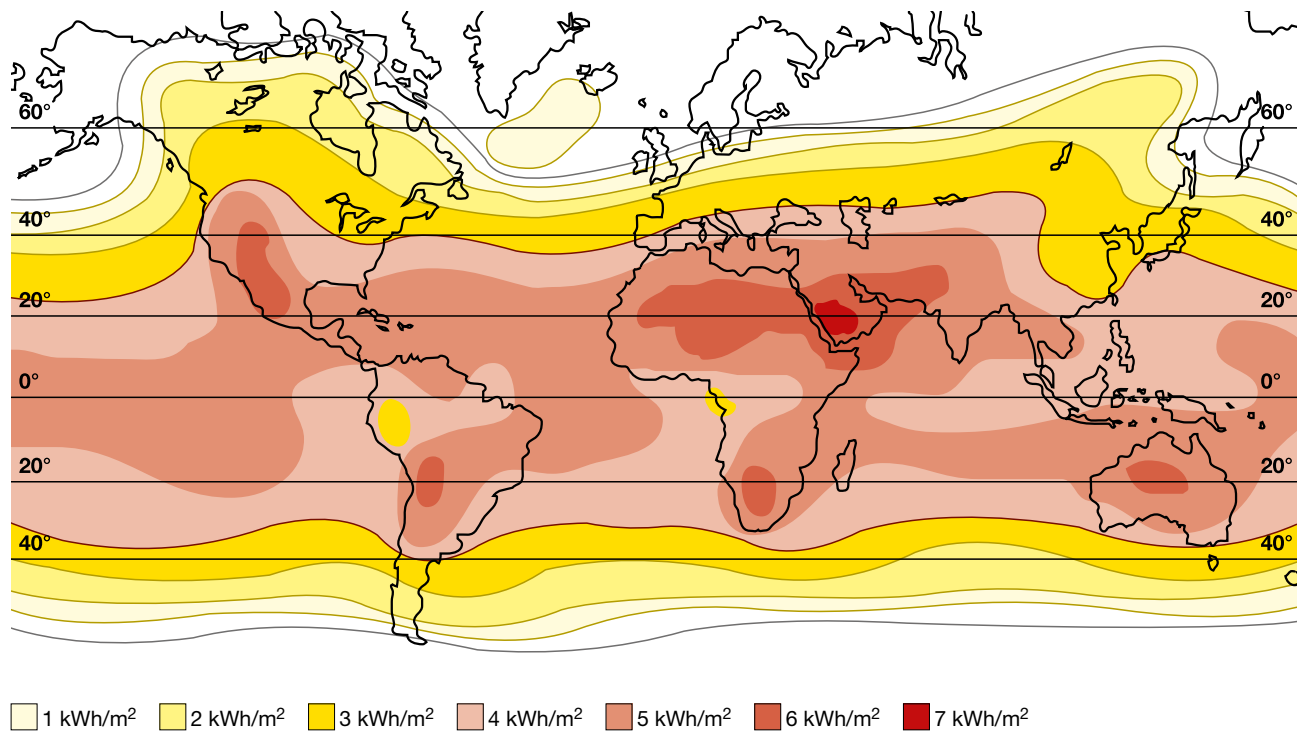

In Italy the average annual irradiance varies from the 3.6 kWh/m² a day of the Po Valley to the 4.7 kWh/m² a day in the South-Centre and the 5.4 kWh/m²/day of Sicily (Figure 1.6). Therefore, in the favorable regions of the South it is pos-

sible to draw about 2 MWh/m² (5.4 · 365) per year, that is the energetic equivalent of 1.5 petroleum barrels for each square meter, whereas the rest of Italy ranges from the 1750 kWh/m² of the Tyrrhenian strip and the 1300 kWh/m² of the Po Valley.

Figure 1.6 - Daily global radiation in kWh/m²

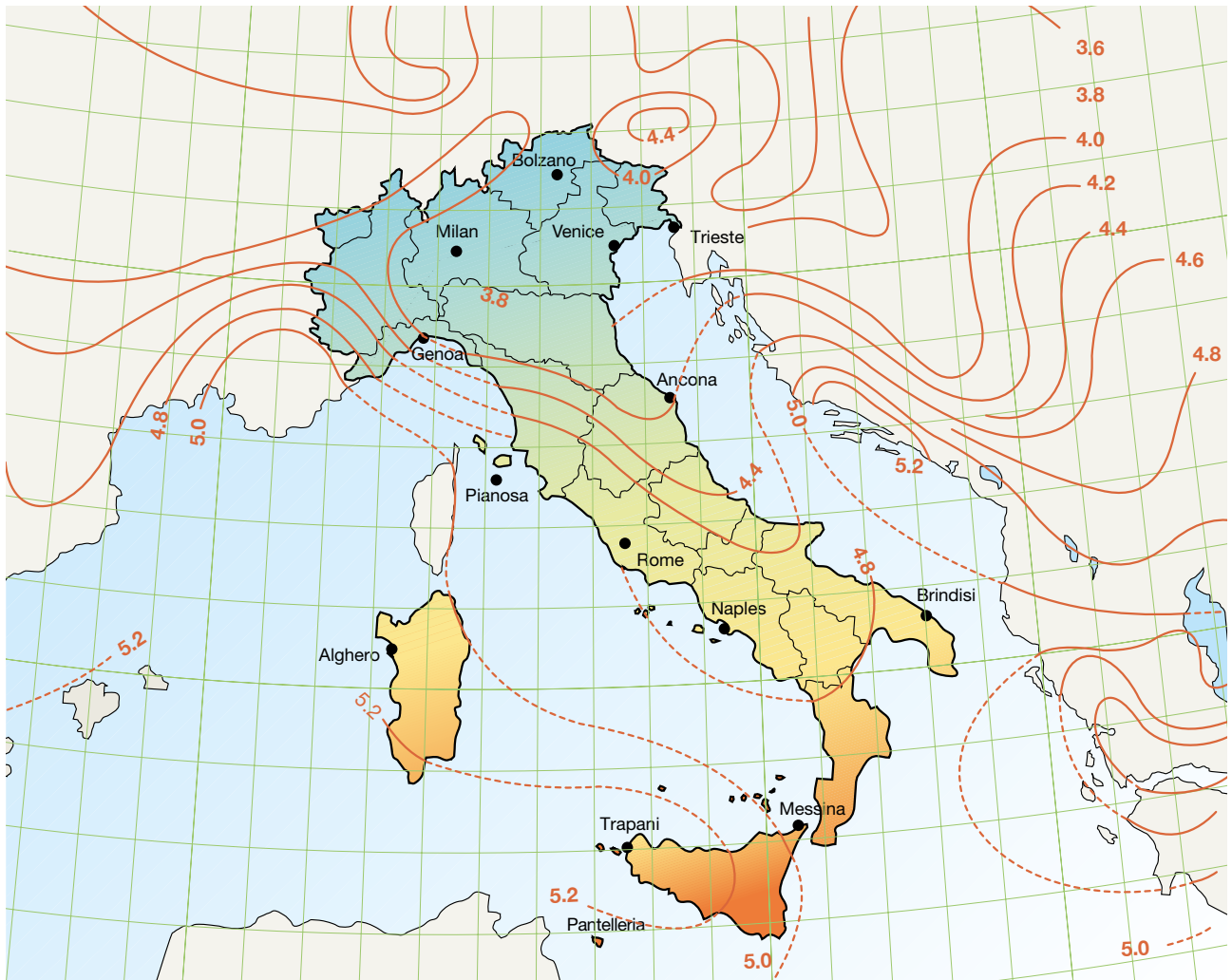

1.3 Main components of a photovoltaic plant

1.3.1 Photovoltaic generator

The elementary component of a PV generator is the photovoltaic cell where the conversion of the solar radiation into electric current is carried out. The cell consists of a thin layer of semiconductor material, generally silicon properly treated, with a thickness of about 0.3 mm and a surface from 100 to 225 cm².

Silicon, which has four valence electrons (tetravalent), is “doped” by adding trivalent atoms (e.g. boron – P doping) on one “layer” and small quantities of pentavalent atoms (e.g. phosphorus – N doping) on the other one.

The P-type region has an excess of holes, whereas the N-type region has an excess of electrons (Figure 1.7).

Figure 1.7 - The photovoltaic cell

Doped silicon

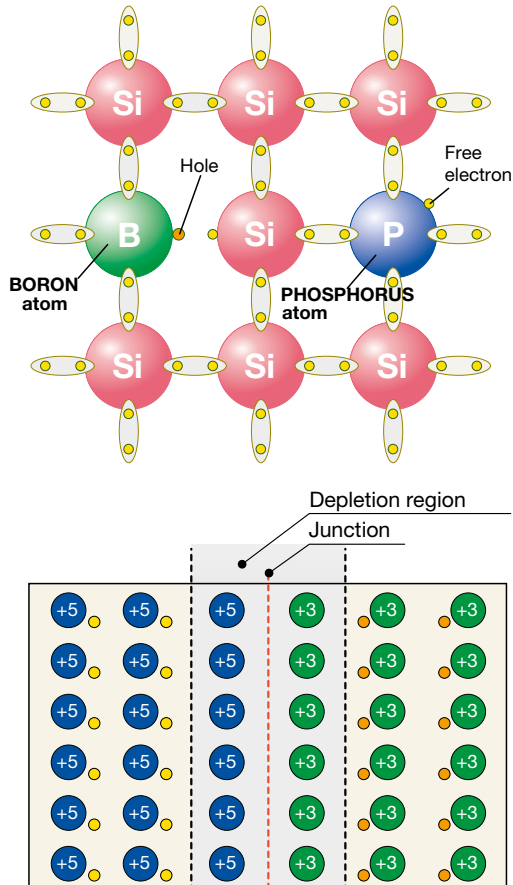

In the contact area between the two layers differently doped (P-N junction), the electrons tend to move from the electron rich region (N) to the electron poor region (P), thus generating an accumulation of negative charge in the P region. A dual phenomenon occurs for the electron holes, with an accumulation of positive charge in the region N. Therefore an electric field is created across the junction and it opposes the further diffusion of electric charges. By applying a voltage from the outside, the junction allows the current to flow in one direction only (diode functioning).

When the cell is exposed to light, due to the photovoltaic effect², some electron-hole couples arise both in the N region as well as in the P region. The internal electric field allows the excess electrons (derived from the absorption of the photons from part of the material) to be separated from the holes and pushes them in opposite directions in relation one to another.

As a consequence, once the electrons have passed the depletion region they cannot move back since the field prevents them from flowing in the reverse direction. By connecting the junction with an external conductor, a closed circuit is obtained, in which the current flows from the layer P, having higher potential, to the layer N, having lower potential, as long as the cell is illuminated (Figure 1.8).

Figure 1.8 - How a photovoltaic cell works

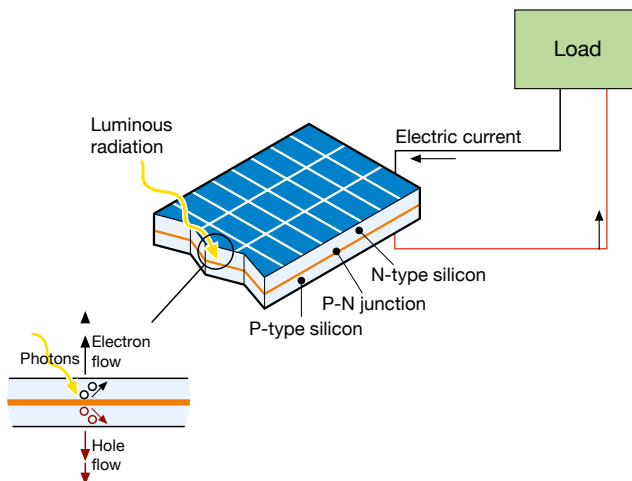

² The photovoltaic effect occurs when an electron in the valence band of a material (generally a semiconductor) is promoted to the conduction band due to the absorption of one sufficiently energetic photon (quantum of electromagnetic radiation) incident on the material. In fact, in the semiconductor materials, as for insulating materials, the valence electrons cannot move freely, but comparing semiconductor materials with insulating materials the energy gap between the valence band and the conduction band (typical of conducting materials) is small, so that the electrons can easily move to the conduction band when they receive enough energy from the outside. Such energy can be supplied by the luminous radiation, hence the photovoltaic effect.

The silicon region which contributes to supply the current is the area surrounding the P-N junction; the electric charges form in the far off areas, but there is not the electric field which makes them move and therefore they recombine. As a consequence it is important that the PV cell has a large surface: the greater the surface, the greater the generated current.

Figure 1.9 represents the photovoltaic effect and the energy balance showing the considerable percentage of incident solar energy which is not converted into electric energy.

Figure 1.9 - Photovoltaic effect

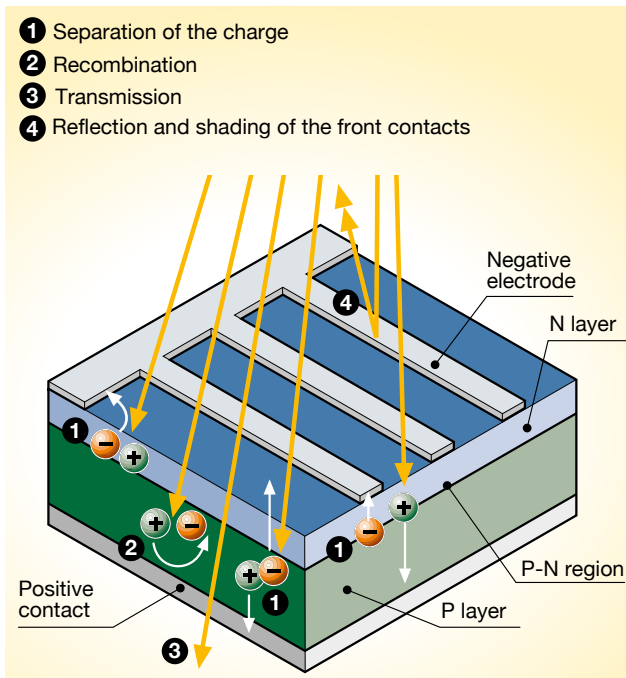

100% of the incident solar energy

- 3% reflection losses and shading of the front contacts
 - 23% photons with high wavelength, with insufficient energy to free electrons; heat is generated
 - 32% photons with short wavelength, with excess energy (transmission)
 - 8.5% recombination of the free charge carriers
 - 20% electric gradient in the cell, above all in the transition regions
 - 0.5% resistance in series, representing the conduction losses
- = 13% usable electric energy**

Under standard operating conditions (1W/m² irradiance at a temperature of 25°C) a PV cell generates a current of about 3A with a voltage of 0.5V and a peak power equal to 1.5-1.7Wp.

On the market there are photovoltaic modules for sale constituted by an assembly of cells. The most common ones comprise 36 cells in 4 parallel rows connected in series, with an area ranging from 0.5 to 1m². Several modules mechanically and electrically connected form a panel, that is a common structure which can be anchored to the ground or to a building (Figure 1.10).

Figure 1.10



Several panels electrically connected in series constitute an array and several arrays, electrically connected in parallel to generate the required power, constitute the generator or photovoltaic field (Figures 1.11 and 1.12).

Figure 1.11

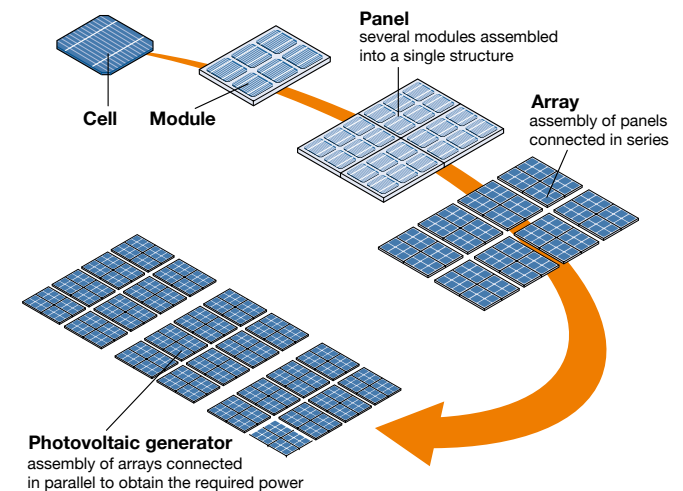

Figure 1.12



The PV cells in the modules are not exactly alike due to the unavoidable manufacturing deviations; as a consequence, two blocks of cells connected in parallel between them can have different voltage. As a consequence, a flowing current is created from the block of cells at higher voltage towards the block at lower voltage. Therefore, a part of the power generated by the module is lost within the module itself (mismatch losses).

The inequality of the cells can be determined also by different solar irradiance, for example when a part of cells are shaded or when they are deteriorated.

These cells behave as a diode, blocking the current generated by the other cells.

The diode is subject to the voltage of the other cells and it may cause the perforation of the junction with local overheating and damages to the module.

Therefore the modules are equipped with by-pass diodes to limit such phenomenon by short-circuiting the shaded or damaged part of the module.

The phenomenon of mismatch arises also between the arrays of the photovoltaic field, due to inequality of modules, different irradiance of the arrays, shadings and faults in an array.

To avoid reverse current flowing among the arrays it is possible to insert diodes.

The cells forming the module are encapsulated in an assembly system which:

- electrically insulates the cells towards the outside;
- protects the cells against atmospheric agents and against mechanical stresses;
- resists ultra violet rays at low temperatures, sudden changes of temperature and abrasion;
- gets rid of heat easily so as to prevent the temperature rise from reducing the power supplied by the module.

Such properties must remain for the expected lifetime of the module.

Figure 1.13 shows the cross-sectional area of a standard module in crystalline silicon, made up by:

- a protective sheet on the upper side exposed to light, characterized by high transparency (the most used material is tempered glass);
- an encapsulation material to avoid the direct contact

between glass and cell, to eliminate the interstices due to surface imperfections of the cells and electrically insulate the cell from the rest of the panel; in the processes where the lamination phase is required Ethylene Vinyl Acetate (EVA) is often used;

- a rear supporting substratum (glass, metal, plastic);
- a metal frame, usually made of aluminium.

Figure 1.13

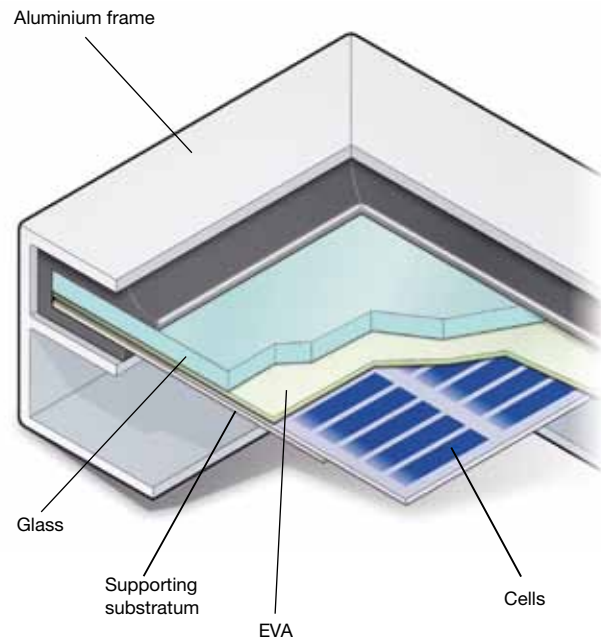

To connect the cells, in the crystal silicon modules, metallic contacts soldered after the construction of the cells are used; in the thin film modules the electrical connection is a part of the manufacturing process of the cells and it is ensured by a layer of transparent metal oxides, such as zinc oxide or tin oxide.

1.3.2 Inverter

The power conditioning and control system is constituted by an inverter that converts direct current to alternating current and controls the quality of the output power to be delivered to the grid, also by means of an L-C filter inside the inverter itself.

Figure 1.14 shows the principle scheme of an inverter. The transistors, used as static switches, are controlled by an opening-closing signal which, in the simplest mode, would result in an output square waveform.

Figure 1.14 – Principle scheme of a single-phase inverter

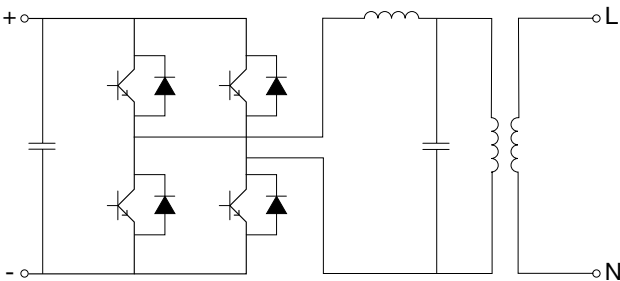

To obtain a waveform as sinusoidal as possible, a more sophisticated technique – Pulse Width Modulation (PWM) – is used; PWM technique allows a regulation to be achieved on the frequency as well as on the r.m.s. value of the output waveform (Figure 1.15).

Figure 1.15 – Operating principle of the PWM technology

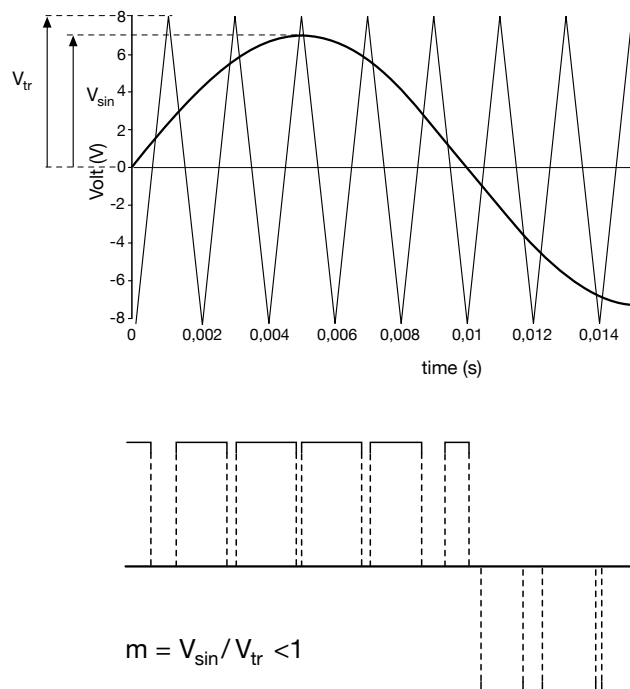

The power delivered by a PV generator depends on the point where it operates.

In order to maximize the power supplied by the plant, the generator shall adapt to the load, so that the operating point always corresponds to the maximum power point. To this purpose, a controlled chopper called Maximum Power Point Tracker (MPPT) is used inside the inverter; the MPPT calculates instant by instant the pair of values “voltage-current” of the generator at which the maximum available power is produced. Starting from the I-V curve of the PV generator:

Maximum Power Point for a photovoltaic generator

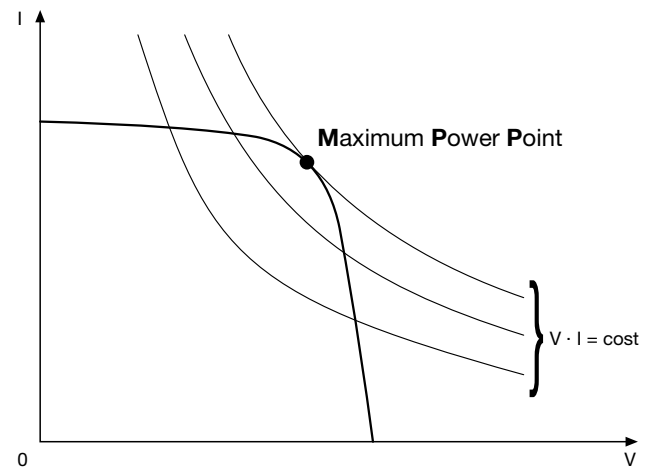

The maximum point of power transfer corresponds to the point of tangency between the I-V characteristic curve for a given value of solar radiation and the hyperbola of equation $V \cdot I = \text{cost}$.

The MPPT systems commercially used identify the maximum power point on the characteristic curve of the generator by provoking, at regular intervals, small variations of loads which determine deviations of the voltage-current values and evaluating if the new product $I \times V$ is higher or lower than the previous one. In case of a rise, the load conditions are kept varying in the considered direction. Otherwise, the conditions are modified in the opposite direction.

Due to the characteristics of the required performances, the inverters for off-grid plants and for grid-connected plants shall have different characteristics:

- in off-grid plants the inverters shall be able to supply a voltage on the AC side as constant as possible at the varying of the production of the generator and of the load demand;
- in grid-connected plants the inverters shall reproduce, as exactly as possible, the network voltage and at the same time try to optimize and maximize the power output of the PV modules.

1.4 Types of photovoltaic modules

1.4.1 Crystal silicon modules

Crystal silicon modules are currently the most used in the installed plants and are divided into three categories:

- monocrystalline (single-crystalline) modules (Figure 1.16), homogeneous single crystal modules are made of silicon crystal of high purity. The single-crystal silicon ingot has cylindrical form, 13-20 cm diameter and 200 cm length, and is obtained by growth of a filiform crystal in slow rotation. Afterwards, this cylinder is sliced into wafers 200-250 μm thick and the upper surface is treated to obtain “microgrooves” aimed at minimizing the reflection losses. The main benefit of these cells is the efficiency (16-16.5%, whereas it is 20 to 22% for high performance modules) together with high duration and conservation of the characteristics in time³. The price of such modules is about 0.70 €/W and the modules made with this technology are usually characterized by a homogenous dark blue color⁴.
- polycrystalline modules (Figure 1.17), in which the crystals constituting the cells aggregate taking different forms and directions. In fact, the iridescences typical of poly-crystalline silicon cells are caused by the different

direction of the crystals and the consequent different behavior with respect to light. The polycrystalline silicon ingot is obtained by melting and casting the silicon into a parallelepiped-shaped mould. The wafers thus obtained are square shape and have typical striations of 180-300 μm thickness.

The efficiency is lower in comparison with monocrystalline modules (15 to 16%, whereas it is 18 to 20% for high performance modules), but also the cost: 0.67 €/W. Anyway, the duration is high (comparable to single crystalline silicon) and also the maintenance of performances in time (85% of the initial efficiency after 20 years). The cells made with such technology can be recognized because of the surface aspect where crystal grains are quite visible.

- almost-monocrystalline modules, with an intermediate structure between single- and multi-crystalline ones. The method to obtain the ingots is similar to that used to produce polycrystalline modules: in particular, a monocrystalline silicon crystal is placed on the bottom of the pot and it acts as the “condensation nucleus” from which large-sized crystals form. The cooling of the ingot shall be slow so as to allow the crystals grow without splitting and shall occur in the direction from the silicon nucleus to the top.

Figure 1.16 – Monocrystalline silicon module



Figure 1.17 – Polycrystalline silicon module



³ Some manufacturers guarantee the modules for 20 years, with a maximum loss of efficiency of 10% with respect to the nominal value.

⁴ The dark blue color is due to the titan oxide antireflective coating, which has the purpose of improving the collection of solar radiation.

Nowadays the market is dominated by crystal silicon technology, which represents about 90% of it. Such technology is ripe as regards both obtainable efficiency and manufacturing costs and it will probably continue to dominate the market in the short-medium period. Only some slight improvements are expected in terms of efficiency and a possible reduction of the costs linked both to the introduction in the industrial process of bigger and thinner wafers as well as to the economies of scale. In particular, thanks to the selective emitter technique, it is possible to increase the efficiency up to 0.8% through an increase in the concentration of the doping element (phosphorous) in the area under the metallic contacts in order to decrease the resistance in such area without increasing, however, the dimension of the metallic contact. Therefore, this technique allows the resistance of the contacts to be reduced above the cells without decreasing the surface of captation of the solar radiation and therefore without affecting negatively its optical performance.

Besides, the PV industry based on such technology uses the surplus of silicon intended for the electronics industry but, due to the constant development of the last and to the exponential growth of the PV production in the last years, the availability on the market of raw material to be used in the photovoltaic sector is often difficult.

1.4.2 Thin-film modules

Thin film cells are composed by semiconducting material deposited, usually as gas mixtures, on supports as glass, polymers, aluminium, which give physical consistency to the mixture. The semiconductor film layer is a few μm in thickness with respect to crystalline silicon cells which are some hundreds μm . As a consequence, the saving of material is remarkable and the possibility of having a flexible support increases the application field of thin film cells (Figure 1.18).

Figure 1.18 – Thin film module

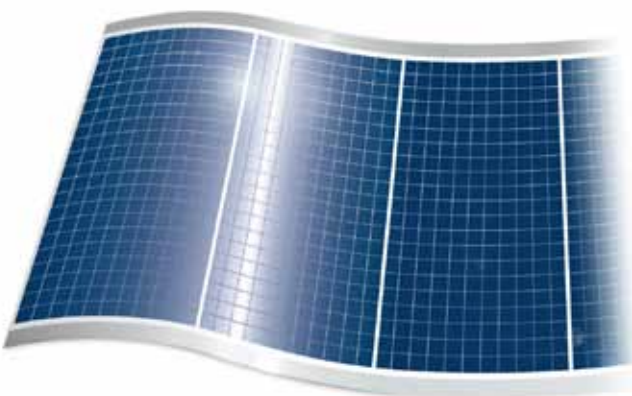

The materials mainly used are:

- amorphous silicon (a-Si)
- cadmium telluride (CdTe)
- indium diselenide and copper alloys (CIS, CIGS, CIGSS)
- gallium arsenide (GaAs)

Amorphous silicon deposited as film on a support (e.g. aluminium) offers the opportunity of having PV technology at reduced costs in comparison with crystalline silicon, but the efficiency of these cells tends to get worse in the time. Amorphous silicon can also be “sprayed” on a thin sheet of plastic or flexible material. It is used above all when it is necessary to reduce maximally the weight of the panel and to adapt it to curved surfaces.

The efficiency is rather low (7 to 8%, whereas for high performance modules it is 10 to 11%) due to the many resistances that the electrons have to face in their flux, but also the cost per unit (0.52 to 0.56 €/W) is lower than for the crystal silicon modules. Also in this case the cell performances tend to get worse in the time. An interesting application of this technology is the “tandem” one (micro-morph silicon cells), combining an amorphous silicon layer with one or more multi-junction crystalline silicon layers; thanks to the separation of the solar spectrum, each junction positioned in sequence works at its best and guarantees higher levels in terms both of efficiency as well as endurance. The efficiency levels reached are interesting: about 11.6% in laboratories and 9% for commercial applications.

The production of *cadmium telluride* modules on a large scale involves the environmental problem of the CdTe contained in the cell: since it is not soluble in water and it is more stable than other compounds containing

Figure 1.19 – Structures of thin film cells CdTe-CdS based

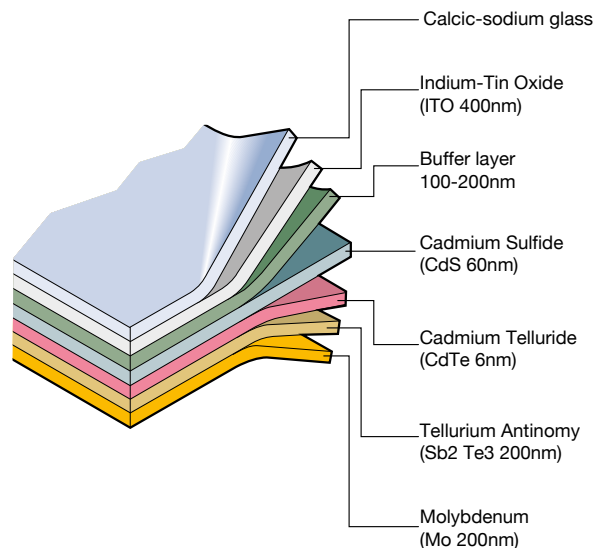

cadmium, it may become a problem when not properly recycled or used (Figure 1.19). CdTeS cells have higher efficiency than amorphous silicon cells (12.4 to 13.4%, and 12.7 to 14.2% for high performance modules) and also a cost per unit slightly higher (0.58-0.60 €/W).

In the CIS/CIGS/CIGSS modules, instead of silicon, some special alloys are used, such as:

- copper, indium and selenite (CIS);
- copper, indium, gallium and selenite (CIGS);
- copper, indium, gallium, selenite and sulphur (CIGSS).

The efficiency is about 14.1 to 14.6% (15% for high performance modules) and the performances remain unchanged over the time; as for crystal silicon, a reduction is foreseen for the unit cost, which is actually about 0.65 €/W.

Nowadays, *GaAs technology* is the most interesting one if considered from the point of view of the obtained efficiency, higher than 25 to 30%, but the production of such cells is limited by the high costs and by the scarcity of the material, which is prevalingly used in the “high speed semiconductors” and optoelectronics industry. In fact, GaAs technology is mainly used for space applications where weights and reduced dimensions play an important role.

The market share of thin film technologies is limited, but such technologies are taken into consideration as the solution with the highest potentiality in the medium-long term, also for a substantial price reduction.

By depositing the thin film directly on a large scale, more than 5 m², the scraps, which are typical of the slicing operation to get crystalline silicon wafers from the initial ingot, are avoided.

⁵ According to some studies in this field, by 2020 the market share of thin films could reach 30% to 40%.

The deposition techniques are low power consumption processes and consequently the relevant payback time is short, that is only the time for which a PV plant shall be running before the power used to build it has been generated (about 1 year for amorphous silicon thin films against the 2 years of crystalline silicon).

In comparison with crystalline silicon modules, thin film modules show a lower dependence of efficiency on the operating temperature and a good response also when the diffused light component is more marked and the radiation levels are low, above all on cloudy days.

Table 1.1

	Single crystalline silicon	Polycrystalline silicon	Amorphous silicon
η Cell	16% to 17%	14% to 16%	7% to 8%
Benefits	High η η constant Reliable technology	Lower cost, simpler production, optimum overall dimensions	Lower cost, reduced influence of the temperature, higher power output with diffused radiation
Disadvantages	Higher quantity of power necessary for production	Sensitivity to impurities in the manufacturing process	Larger dimensions, cost of the structure and assembly time

Table 1.2

	GaAs (Gallium Arsenide)	Cadmium Telluride	CIS (Copper Iridium Selenide alloys)
η Cell	32.5%	12.4% - 13.4%	13.6 - 14.6%
Benefits	High resistance at high temperatures (ok for concentrators)	Basso costo	Molto stabile
Disadvantages	Toxicity, availability of the materials	Toxicity, availability of the materials	Toxicity

1.5 Types of photovoltaic plants

1.5.1 Off-grid plants

Off-grid plants are plants which are not connected to the grid and consist of PV modules and of a storage system which guarantees electric energy supply also when lighting is poor or when it is dark. Since the current delivered by the PV generator is DC power, if the user plant needs AC current an inverter becomes necessary.

Such plants are advantageous from a technical and financial point of view since they can replace motor generator sets whenever the electric network is not present or whenever it is not easy to reach. Besides, in an off-grid configuration, the PV field is over-dimensioned so that, during the insolation hours, both the load supply as well as the recharge of the storing batteries can be guaranteed with a certain safety margin taking into account the days of poor insolation.

At present the most common applications are used to supply (Figure 1.20):

- pumping water equipment;
- radio repeaters, weather or seismic observation and data transmission stations;
- lightning systems;
- systems of signs for roads, harbors and airports;
- service supply in campers;
- advertising installations;
- refuges at high altitudes.

Figure 1.20 - Photovoltaic shelters and street lamps supplied by photovoltaic power



Figure 1.21 shows a principle diagram of a PV plant working off-grid.

Figure 1.21

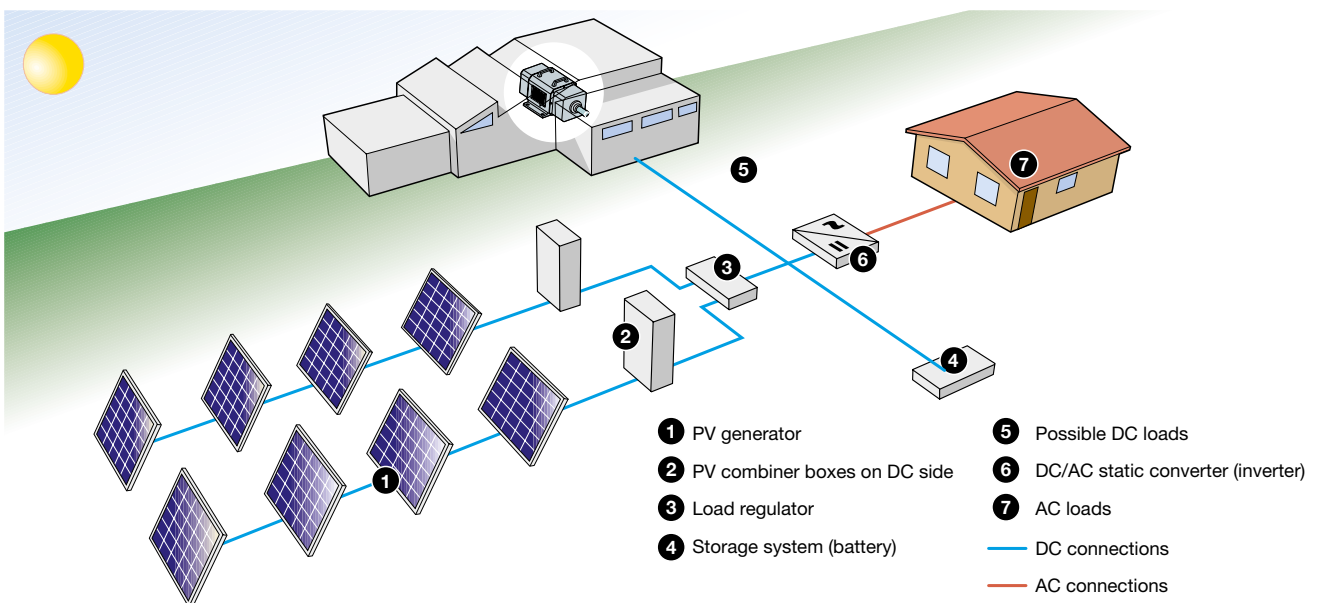

1.5.2 Grid-connected plants

Permanently grid-connected plants draw power from the grid during the hours when the PV generator cannot produce the energy necessary to satisfy the needs of the consumer.

On the contrary, if the PV system produces excess electric power, the surplus is put into the grid, which therefore can operate as a big accumulator: as a consequence, grid-connected systems do not need accumulator banks (Figure 1.22).

Figure 1.22



Figure 1.24

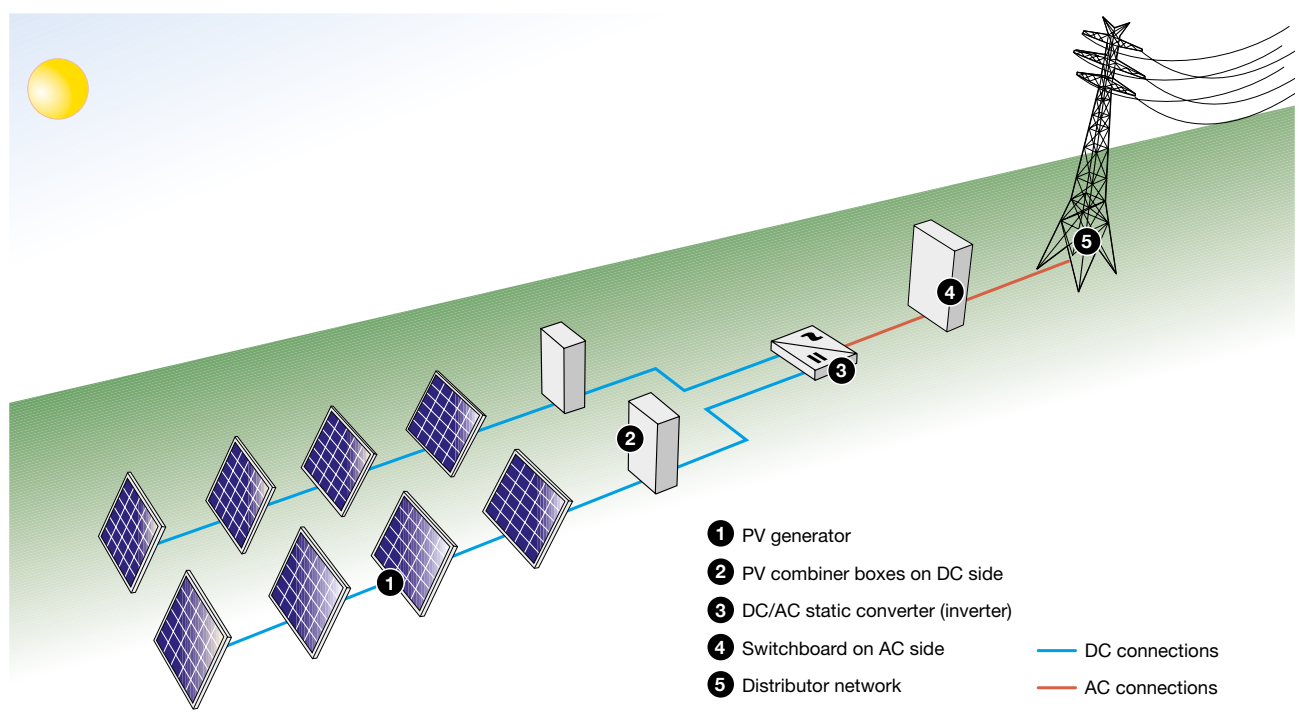
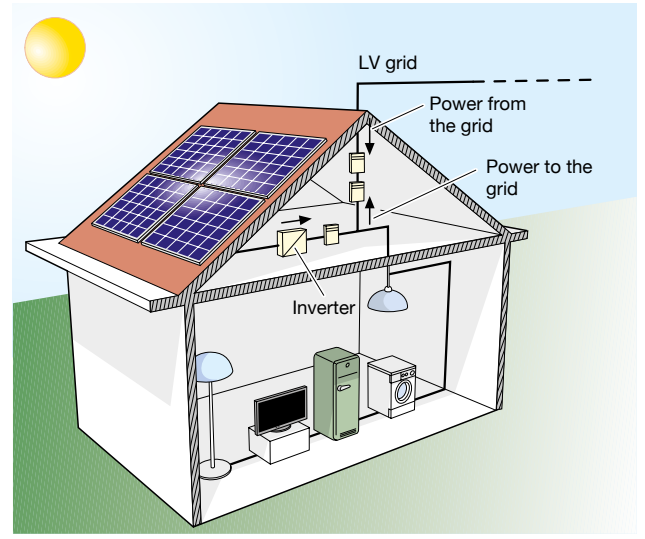

Figure 1.23



Such plants (Figure 1.23) offer the advantage of distributed - instead of centralized - generation: in fact, the energy produced near the consumption area has a value higher than that produced in traditional large power plants, because the transmission losses are limited and the expenses of big transport and dispatch electric systems are reduced. In addition, the energy production in the insolation hours allows the requirements for the grid to be reduced during the day, that is when the demand is higher.

Figure 1.24 shows the principle diagram of a grid-connected photovoltaic plant.

1.6 Intermittence of generation and storage of produced power

PV exploitation on a large scale is affected by a technical limit due to the uncertain intermittency of production. In fact, the national electrical distribution network can accept a limited quantity of intermittent input power, over which serious problems for the stability of the network can arise.

The acceptance limit depends on the network configuration and on the degree of interconnection with the contiguous grids.

In particular, in the Italian situation, it is considered dangerous if the total intermittent power introduced into the network exceeds a value from 10% to 20% of the total power of the traditional power generation plants.

As a consequence, the presence of a constraint due to the intermittency of power generation restricts the real possibility of giving a significant PV contribution to the national energy balance and this remark can be extended to all intermittent renewable sources.

To get round this negative aspect it would be necessary to store for sufficiently long times the intermittent electric power thus produced to put it into the network in a more continuous and stable form.

Electric power can be stored either in big superconducting coils or by converting it into other form of energy: kinetic energy stored in flywheels or compressed gases, gravitational energy in water basins, chemical energy in synthesis fuels and electrochemical energy in electric accumulators (batteries).

Through a technical selection of these options according to the requirement of maintaining energy efficient for days and/or months, two storage systems emerge: that using batteries and the hydrogen one.

At the state of the art of these two technologies, the electrochemical storage seems feasible, in the short-medium term, to store the energy for some hours to some days. Therefore, in relation to photovoltaics applied to small grid-connected plants, the insertion of a storage subsystem consisting in batteries of small dimensions may improve the situation of the inconveniences due to intermittency, thus allowing a partial overcoming of the network limit of acceptance.

As regards the seasonal storage of the huge quantity of electric power required to replace petroleum in all usage sectors, hydrogen seems to be the most suitable technology for the long term, since it takes advantage of the fact that solar electric productivity in summer is higher than winter productivity of about a factor 3.

The exceeding energy stored in summer could be used to optimize the annual capacity factor of renewable source power plants, increasing it from the present value of 1500-1600 hours without storage to a value nearer to the average value of conventional power plants (about 6000 hours).

In this case, the power from the renewable source could replace the thermoelectric one in its role, since the acceptance limit of the grid would be removed.

2 Energy production

2.1 Circuit equivalent to the cell

A photovoltaic cell can be considered as a current generator and can be represented by the equivalent circuit of Figure 2.1.

The current I at the outgoing terminals is equal to the current generated through the PV effect I_g by the ideal current generator, decreased by the diode current I_d and by the leakage current I_l .

The resistance series R_s represents the internal resistance to the flow of generated current and depends on the thick of the junction P-N, on the present impurities and on the contact resistances.

The leakage conductance G_l takes into account the current to earth under normal operation conditions.

In an ideal cell, we would have $R_s=0$ and $G_l=0$.

On the contrary, in a high-quality silicon cell we have $R_s=0.05 \div 0.10 \Omega$ and $G_l=3 \div 5 \text{ mS}$.

The conversion efficiency of the PV cell is greatly affected also by a small variation of R_s , whereas it is much less affected by a variation of G_l .

Figure 2.1

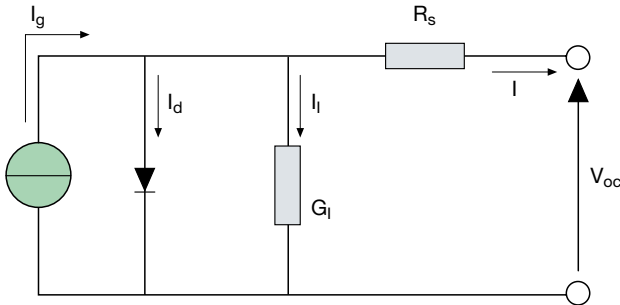

The open circuit voltage V_{oc} occurs when the load does not absorb any current ($I=0$) and is given by the relation:

$$V_{oc} = \frac{I_l}{G_l} \quad [2.1]$$

The diode current is given by the classic formula for direct current:

$$I_d = I_D \cdot \left[e^{\frac{Q \cdot V_{oc}}{A \cdot k \cdot T}} - 1 \right] \quad [2.2]$$

where:

- I_D is the saturation current of the diode;
- Q is the charge of the electron ($1.6 \cdot 10^{-19} \text{ C}$);
- A is the identity factor of the diode and depends on the recombination factors inside the diode itself (for crystalline silicon it is about 2)
- k is the Boltzmann constant ($1.38 \cdot 10^{-23} \frac{\text{J}}{\text{K}}$)
- T is the absolute temperature in K degree

Then, the current supplied to the load is given by:

$$I = I_g - I_d - I_l = I_g - I_D \cdot \left[e^{\frac{Q \cdot V_{oc}}{A \cdot k \cdot T}} - 1 \right] - G_l \cdot V_{oc} \quad [2.3]$$

In the usual cells, the last term of this formula, i.e. the leakage current to earth I_l , is negligible with respect to the other two currents.

As a consequence, the saturation current of the diode can be experimentally determined by applying the open circuit V_{oc} to a not-illuminated cell and measuring the current flowing inside the cell.

2.2 Voltage-current characteristic of the module

The voltage-current characteristic curve of a PV module is shown in Figure 2.2. Under shortcircuit conditions the generated current is at the highest (I_{sc}), whereas, with the circuit open, the voltage (V_{oc} =open circuit voltage) is at the highest.

Under the two above mentioned conditions, the electric power produced in the cell is null, whereas under all the other conditions, when the voltage increases, the produced power rises too: at first it reaches the maximum power point (Pm) and then it falls suddenly near to the open circuit voltage value.

Figure 2.2

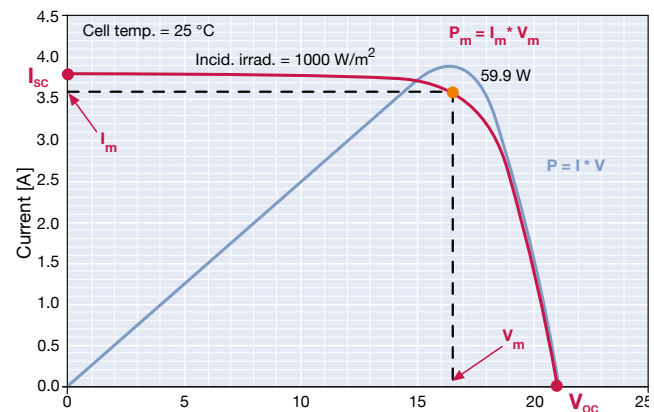

Then, the characteristic data of a PV module can be summarized as follows:

- I_{sc} short-circuit current;
- V_{oc} open circuit voltage;
- P_m maximum produced power under standard conditions (STC);
- I_m current produced at the maximum power point;
- V_m voltage at the maximum power point;
- FF filling factor: it is a parameter which determines the form of the characteristic curve V-I and it is the ratio between the maximum power and the product ($V_{oc} \cdot I_{sc}$) of the no-load voltage multiplied by the short-circuit current.

If a voltage is applied from the outside to the PV cell in reverse direction with respect to standard operation, the generated current remains constant and the power is absorbed by the cell.

When a certain value of inverse voltage (“breakdown” voltage) is exceeded, the junction P-N is perforated, as it occurs in a diode, and the current reaches a high value thus damaging the cell. In absence of light, the generated current is null for reverse voltage values up to the “breakdown” voltage, then there is a discharge current analogously to the lighting conditions (Figure 2.3 – left quadrant).

Figure 2.3

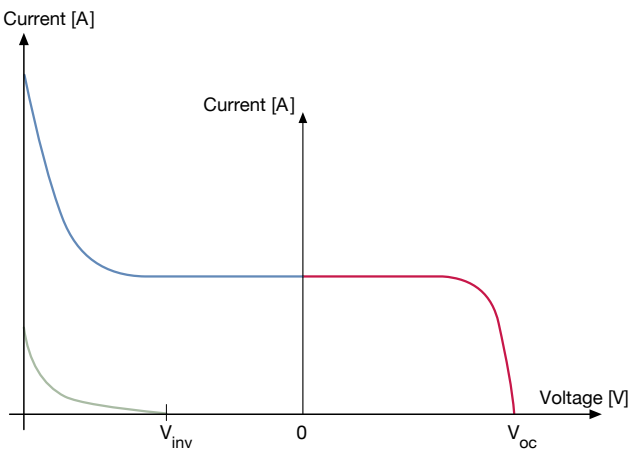

2.3 Grid connection scheme

A PV plant connected to the grid and supplying a consumer plant can be represented in a simplified way by the scheme of Figure 2.4.

The supply network (assumed to be at infinite short-circuit power) is schematized by means of an ideal voltage generator the value of which is independent of the load conditions of the consumer plant.

On the contrary, the PV generator is represented by an ideal current generator (with constant current and equal insolation) whereas the consumer plant is represented by a resistance R_u .

Figure 2.4

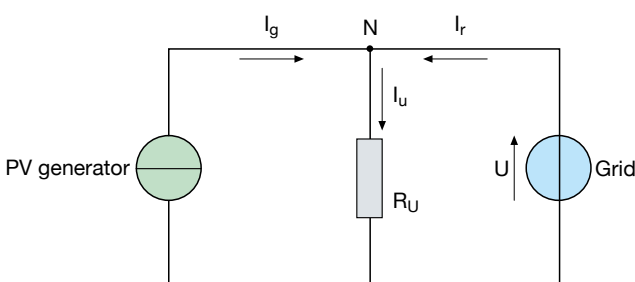

The currents I_g and I_r , which come from the PV generator (I_g) and from the network (I_r) respectively, converge in the node N of Figure 2.4 and the current I_u absorbed by the consumer plant flows out from the node:

$$I_u = I_g + I_r \quad [2.4]$$

Since the current on the load is also the ratio between the network voltage U and the load resistance R_u :

$$I_u = \frac{U}{R_u} \quad [2.5]$$

the relation among the currents becomes:

$$I_r = \frac{U}{R_u} - I_g \quad [2.6]$$

If in the [2.6] we put $I_g = 0$, as it occurs during the night hours, the current absorbed from the grid results:

$$I_r = \frac{U}{R_u} \quad [2.7]$$

On the contrary, if all the current generated by the PV plant is absorbed by the consumer plant, the current supplied by the grid shall be null and consequently the formula [2.6] becomes:

$$I_g = \frac{U}{R_u} \quad [2.8]$$

When the insolation increases, if the generated current I_g becomes higher than that required by the load I_u , the current I_r becomes negative, that is no more drawn from the grid but put into it.

Multiplying the terms of the [2.4] by the network voltage U , the previous considerations can be made also for the powers, assuming as:

- $P_u = U \cdot I_u = \frac{U^2}{R_u}$ the power absorbed by the user plant;
- $P_g = U \cdot I_g$ the power generated by the PV plant;
- $P_r = U \cdot I_r$ the power delivered by the grid.

2.4 Nominal peak power

The nominal peak power (kWp) is the electric power that a PV plant is able to deliver under standard testing conditions (STC):

- 1 kW/m² insolation perpendicular to the panels;
- 25°C temperature in the cells;
- air mass (AM) equal to 1.5.

The air mass influences the PV energy production since it represents an index of the trend of the power spectral density of solar radiation. As a matter of fact, the latter has a spectrum with a characteristic W/m²-wavelength which varies also as a function of the air density.

In the diagram of Figure 2.5 the yellow surface represents the radiation perpendicular to the Earth surface, absorbed by the atmosphere, whereas the blue surface represents the solar radiation which really reaches the Earth surface; the difference between the slope of the two curves gives and indication of the spectrum variation due to the air mass¹.

Figure 2.5

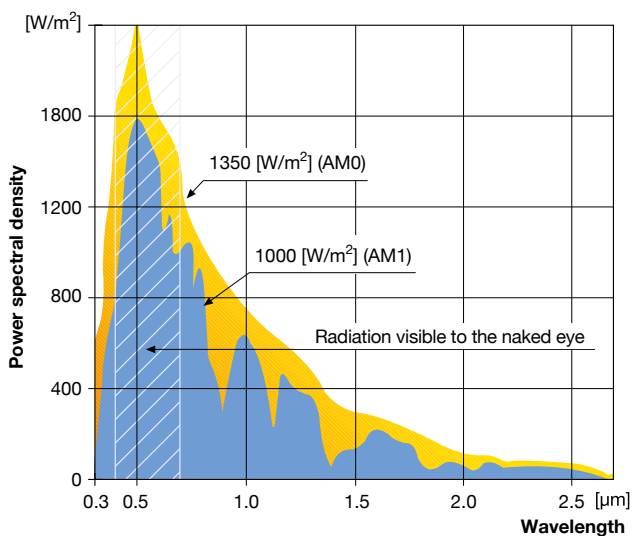

The air mass index AM is calculated as follows:

$$AM = \frac{P}{P_0 \cdot \sin(h)} \quad [2.9]$$

where:

- P is the atmospheric pressure measured at the point and instant considered [Pa];
- P₀ is the reference atmospheric pressure at the sea level [1.013 · 10⁵ Pa];
- h is the zenith angle, i.e. the elevation angle of the Sun above the local horizon at the instant considered.

¹ The holes in the insolation correspond to the frequencies of solar radiation absorbed by the water vapor present in the atmosphere.

Remarkable values of AM are (Figure 2.6):

AM = 0 outside the atmosphere where P = 0;

AM = 1 at sea level in a day with clear sky and the sun at the zenith (P = P₀, sen(h) = 1);

AM = 2 at sea level in a beautiful day with the sun at a 30° angle above the horizon (P = P₀, sen(h) = $\frac{1}{2}$).

Figure 2.6

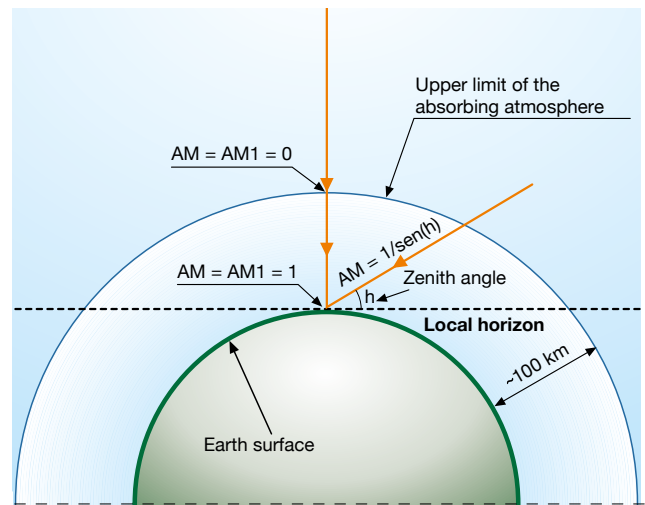

2.5 Expected energy production per year

From an energetic point of view, the design principle usually adopted for a PV generator is maximizing the pick up of the available annual solar radiation. In some cases (e.g. off-grid PV plants) the design criterion could be optimizing the energy production over definite periods of the year.

The electric power that a PV installation can produce in a year depends above all on:

- availability of the solar radiation;
- orientation and inclination of the modules;
- efficiency of the PV installation

Since solar radiation is variable in time, to determine the electric energy which the plant can produce in a fixed time interval, the solar radiation relevant to that interval is taken into consideration, assuming that the performances of the modules are proportional to the insolation. For example, the values of the average solar radiation in Italy can be deduced from:

- the Italian Std. UNI 10349: Heating and cooling of the buildings. Climatic data
- the European Solar Atlas based on the data registered

by the CNR-IFA (Institute of Atmospheric Physics) in the period 1966-1975. It reports isoradiation maps of the Italian and European territory on both horizontal and inclined surfaces

- the ENEA data bank: since 1994 ENEA collects the data of the solar radiation in Italy through the images of the Meteosat satellite.

The maps obtained up to now have been collected in two publications: one relevant to the year 1994 and another one relevant to the period 1995-1999.

Tables 2.1 and 2.2 represent respectively, for different Italian sites, the values of the average annual solar radiation on the horizontal plane [kWh/m²] according to the Std. UNI 10349, and the mean daily values month by month [kWh/m²/day] from ENEA source.

The annual solar radiation for a given site may vary from a source to the other also by 10%, since it derives from the statistical processing of data gathered over different periods; moreover, these data are subject to the variation of the weather conditions from one year to the other. As a consequence, the insolation values have a probabilistic significance, since they represent an expected value, not a definite one.

Starting from the mean annual radiation E_{ma} , to obtain the expected produced energy per year E_p , for each kWp, the following formula is applied:

$$E_p = E_{ma} \cdot \eta_{BOS} \text{ [kWh/kWp]} \quad [2.10]$$

Table 2.1

Annual solar radiation on the horizontal plane - UNI 10349

Site	Annual solar radiation (kWh/m ²)	Site	Annual solar radiation (kWh/m ²)	Site	Annual solar radiation (kWh/m ²)	Site	Annual solar radiation (kWh/m ²)	Site	Annual solar radiation (kWh/m ²)
Agrigento	1923	Caltanissetta	1831	Lecce	1639	Pordenone	1291	Savona	1384
Alessandria	1275	Cuneo	1210	Livorno	1511	Prato	1350	Taranto	1681
Ancona	1471	Como	1252	Latina	1673	Parma	1470	Teramo	1487
Aosta	1274	Cremona	1347	Lucca	1415	Pistoia	1308	Trento	1423
Ascoli Piceno	1471	Cosenza	1852	Macerata	1499	Pesaro-Urbino	1411	Torino	1339
L'Aquila	1381	Catania	1829	Messina	1730	Pavia	1316	Trapani	1867
Arezzo	1329	Catanzaro	1663	Milan	1307	Potenza	1545	Terni	1409
Asti	1300	Enna	1850	Mantova	1316	Ravenna	1411	Trieste	1325
Avellino	1559	Ferrara	1368	Modena	1405	Reggio Calabria	1751	Treviso	1385
Bari	1734	Foggia	1630	Massa Carrara	1436	Reggio Emilia	1427	Udine	1272
Bergamo	1275	Florence	1475	Matera	1584	Ragusa	1833	Varese	1287
Belluno	1272	Forlì	1489	Naples	1645	Rieti	1366	Verbania	1326
Benevento	1510	Frosinone	1545	Novara	1327	Rome	1612	Vercelli	1327
Bologna	1420	Genoa	1425	Nuoro	1655	Rimini	1455	Venice	1473
Brindisi	1668	Gorizia	1326	Oristano	1654	Rovigo	1415	Vicenza	1315
Brescia	1371	Grosseto	1570	Palermo	1784	Salerno	1419	Verona	1267
Bolzano	1329	Imperia	1544	Piacenza	1400	Siena	1400	Viterbo	1468
Cagliari	1635	Isernia	1464	Padova	1266	Sondrio	1442		
Campobasso	1597	Crotone	1679	Pescara	1535	La Spezia	1452		
Caserta	1678	Lecco	1271	Perugia	1463	Siracusa	1870		
Chieti	1561	Lodi	1311	Pisa	1499	Sassari	1669		

Table 2.2

Site	January	February	March	April	May	June	July	August	September	October	November	December
Milan	1.44	2.25	3.78	4.81	5.67	6.28	6.31	5.36	3.97	2.67	1.64	1.19
Venice	1.42	2.25	3.67	4.72	5.75	6.31	6.36	5.39	4.08	2.72	1.64	1.14
Bologna	1.50	2.28	3.81	4.81	5.86	6.42	6.47	5.47	4.19	2.81	1.72	1.25
Florence	1.58	2.33	3.75	4.72	5.86	6.39	6.44	5.50	4.17	2.86	1.83	1.39
Rome	1.92	2.61	3.94	4.92	6.08	6.56	6.58	5.72	4.39	3.17	2.11	1.58
Naples	1.92	2.67	3.92	5.03	6.08	6.64	6.58	5.81	4.50	3.28	2.17	1.69
Bari	1.86	2.58	3.97	5.08	6.08	6.69	6.64	5.81	4.53	3.25	2.08	1.69
Messina	2.11	2.94	4.19	5.19	6.22	6.69	6.67	5.89	4.64	3.53	2.36	1.94
Siracusa	2.36	3.22	4.33	5.39	6.36	6.78	6.75	6.00	4.81	3.69	2.58	2.17

where:

η_{BOS} (*Balance Of System*) is the overall efficiency of all the components of the PV plant on the load side of the modules (inverter, connections, losses due to the temperature effect, losses due to dissymetries in the performances, losses due to shading and low solar radiation, losses due to reflection...). Such efficiency, in a plant properly designed and installed, may range from 0.75 to 0.85.

Instead, taking into consideration the average daily insolation E_{mg} , to calculate the expected produced energy per year, for each kWp, the following is obtained:

$$E_p = E_{mg} \cdot 365 \cdot \eta_{BOS} \text{ [kWh/kWp]} \quad [2.11]$$

Example 2.1

We want to determine the annual mean power produced by a 3kWp plant, on a horizontal plane, installed in Bergamo, Italy. The efficiency of the plant components is supposed to be equal to 0.75.

From the Table in the Std. UNI 10349, an annual radiation mean of 1276 kWh/m² is obtained. Assuming to be under the standard conditions of 1 kW/m², the expected annual mean production is equal to:

$$E_p = 3 \cdot 1276 \cdot 0.75 = 3062 \text{ kWh}$$

2.6 Inclination and orientation of the modules

The maximum efficiency of a solar panel would be reached if the angle of incidence of solar rays were always 90° . In fact, the incidence of solar radiation varies both according to the latitude as well as to the solar declination during the year. In fact, since the Earth's rotation axis is tilted by about 23.45° with respect to the plane of the Earth orbit about the Sun, at definite latitude the height of the Sun on the horizon varies daily.

The Sun is positioned at 90° angle of incidence with respect to the Earth surface (zenith) at the equator in the two days of the equinox and along the tropics at the solstices (Figure 2.7).

Figure 2.7

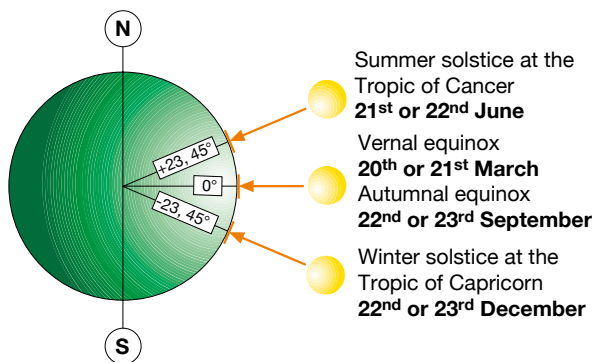

Outside the Tropics latitude, the Sun cannot reach the zenith above the Earth's surface, but it shall be at its highest point (depending on the latitude) with reference to the summer solstice day in the northern hemisphere and in the winter solstice day in the southern hemisphere. Therefore, if we wish to incline the modules so that they can be struck perpendicularly by the solar rays at noon of the longest day of the year, it is necessary to know the maximum height (in degrees) which the Sun reaches above the horizon at that instant, which can be obtained by the following formula:

$$\alpha = 90^\circ - \text{lat} + \delta \quad [2.12]$$

where:

lat is the value (in degrees) of latitude of the installation site of the panels;

δ is the angle of solar declination [23.45°]

Finding the complementary angle of α ($90^\circ - \alpha$), it is possible to obtain the tilt angle β of the modules with respect to the horizontal plane (IEC/TS 61836) so that the panels are struck perpendicularly by the solar rays in the above mentioned moment².

However, it is not sufficient to know the angle α to determine the optimum orientation of the modules.

It is necessary to take into consideration also the Sun path through the sky over the different periods of the year and therefore the tilt angle should be calculated taking into consideration all the days of the year³ (Figure 2.8). This allows to obtain a total annual radiation captured by the panels (and therefore the annual energy production) higher than that obtained under the previous irradiance condition perpendicular to the panels during the solstice.

Figure 2.8

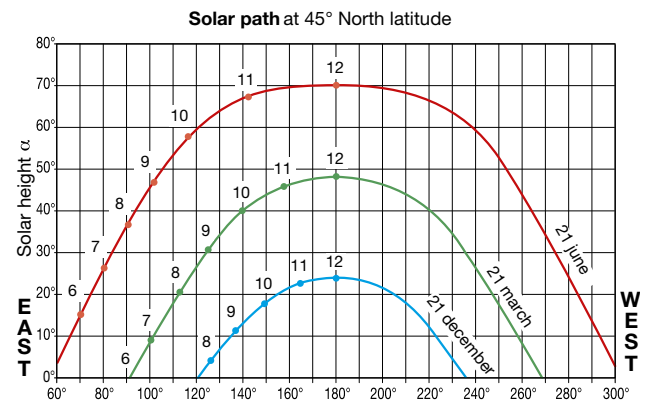

The fixed modules should be oriented as much as possible to south in the northern hemisphere⁴ to get a better insolation of the panel surface at noon local hour and a better global daily insolation of the modules.

The orientation of the modules may be indicated with the Azimuth⁵ angle (γ) of deviation with respect to the optimum direction to south (for the locations in the northern hemisphere) or to north (for the locations in the southern hemisphere).

² On gabled roofs the tilt angle is determined by the inclination of the roof itself.

³ For example, in Italy, the optimum tilted angle is about 30° .

⁴ Since the solar irradiance is maximum at noon, the collector surface must be oriented to south as much as possible. On the contrary, in the southern hemisphere, the optimum orientation is obviously to north.

⁵ In astronomy, the Azimuth angle is defined as the angular distance along the horizon, measured from north (0°) to east, of the point of intersection of the vertical circle passing through the object.

Positive values of the Azimuth angles show an orientation to west, whereas negative values show an orientation to east (IEC 61194).

As regards ground-mounted modules, the combination of inclination and orientation determines the exposition of the modules themselves (Figure 2.9). On the contrary, when the modules are installed on the roofs of buildings, the exposition is determined by the inclination and the orientation of the roof pitches. Good results are obtained through collectors oriented to south-east or to south-west with a deviation with respect to the south up to 45° (Figure 2.10).

Greater deviations can be compensated by means of a slight enlargement of the collector surface.

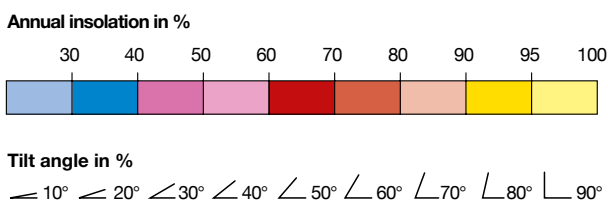
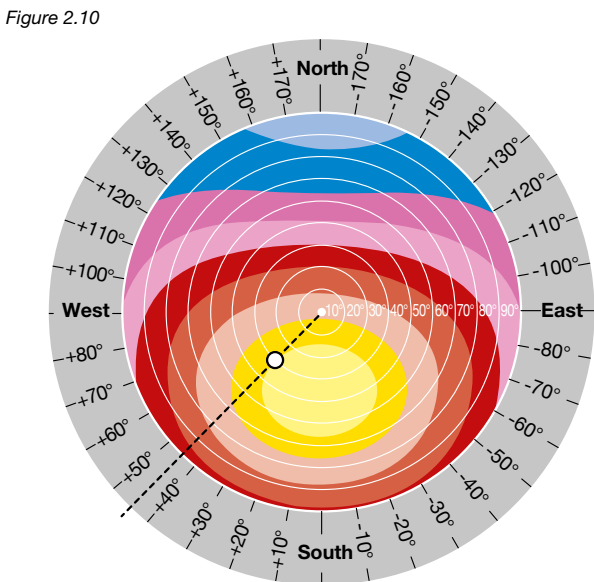
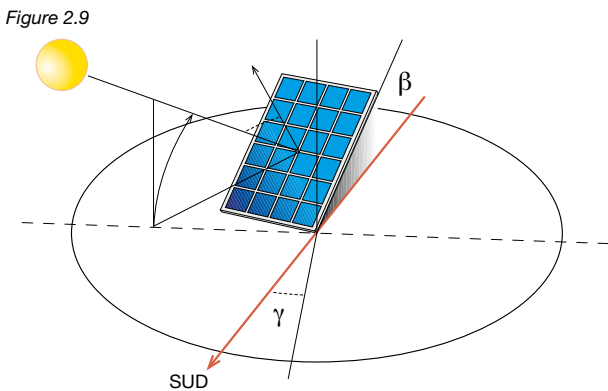

O : Example: 30°; 45° South-West; ≈ 95%

A non-horizontal module receives, in addition to direct and diffuse radiation, also the radiation reflected by the surface surrounding it (albedo component).

An albedo coefficient of 0.2 is usually assumed.

For a first evaluation of the annual production capability of electric power in a PV installation, it is usually sufficient to apply to the annual mean radiation on the horizontal plane (Tables 2.1-2.2) the correction coefficients of Tables 2.3-2.4-2.5⁶ (referred to the Italian context).

⁶ Assumed Albedo: 0.2.

Table 2.3 – Northern Italy: 44°N latitude

Inclination	Orientation				
	0° (south)	± 15°	± 30°	± 45°	± 90° (east, west)
0°	1.00	1.00	1.00	1.00	1.00
10°	1.07	1.06	1.06	1.04	0.99
15°	1.09	1.09	1.07	1.06	0.98
20°	1.11	1.10	1.09	1.07	0.96
30°	1.13	1.12	1.10	1.07	0.93
40°	1.12	1.11	1.09	1.05	0.89
50°	1.09	1.08	1.05	1.02	0.83
60°	1.03	0.99	0.96	0.93	0.77
70°	0.95	0.95	0.93	0.89	0.71
90°	0.74	0.74	0.73	0.72	0.57

Table 2.4 – Central Italy: 41°N latitude

Inclination	Orientation				
	0° (south)	± 15°	± 30°	± 45°	± 90° (east, west)
0°	1.00	1.00	1.00	1.00	1.00
10°	1.07	1.07	1.06	1.04	0.99
15°	1.09	1.09	1.08	1.06	0.97
20°	1.11	1.11	1.09	1.07	0.96
30°	1.13	1.12	1.10	1.07	0.92
40°	1.12	1.12	1.09	1.05	0.87
50°	1.09	1.08	1.05	1.01	0.82
60°	1.03	1.02	0.99	0.96	0.76
70°	0.94	0.94	0.92	0.88	0.70
90°	0.72	0.72	0.71	0.70	0.56

Table 2.5 – Southern Italy: 38°N latitude

Inclination	Orientation				
	0° (south)	± 15°	± 30°	± 45°	± 90° (east, west)
0°	1.00	1.00	1.00	1.00	1.00
10°	1.06	1.06	1.05	1.04	0.99
15°	1.08	1.08	1.07	1.05	0.97
20°	1.10	1.09	1.08	1.06	0.96
30°	1.11	1.10	1.08	1.06	0.92
40°	1.10	1.09	1.07	1.03	0.87
50°	1.06	1.05	1.03	0.99	0.82
60°	0.99	0.99	0.96	0.93	0.75
70°	0.91	0.91	0.88	0.86	0.69
90°	0.68	0.68	0.68	0.67	0.55

Example 2.2

We wish to determine the annual mean energy produced by the PV installation of the previous example, now arranged with +15° orientation and 30° inclination.

From Table 2.3 an increasing coefficient equal to 1.12 is obtained. Multiplying this coefficient by the energy expected on the horizontal plan and obtained in the previous example, the expected production capability becomes:

$$E = 1.12 \cdot E_p = 1.12 \cdot 3062 \approx 3430 \text{ kWh}$$

2.7 Voltages and currents in a PV plant

PV modules generate a current from 4 to 10A at a voltage from 30 to 40V.

To get the projected peak power, the modules are electrically connected in series to form the strings, which are connected in parallel.

The trend is to develop strings constituted by as many modules as possible, because of the complexity and cost of wiring, in particular of the paralleling switchboards between the strings.

The maximum number of modules which can be connected in series (and therefore the highest reachable voltage) to form a string is determined by the operation range of the inverter (see Chapter 3) and by the availability of the disconnection and protection devices suitable for the voltage achieved. In particular, for efficiency reasons, the voltage of the inverter is bound to its power: generally, when using inverter with power lower than 10 kW, the voltage range most commonly used is from 250V to 750V, whereas if the power of the inverter exceeds 10 kW, the voltage range usually is from 500V to 900V.

2.8 Variation in the produced energy

The main factors which influence the electric energy produced by a PV installation are:

- irradiance
- temperature of the modules
- shading.

2.8.1 Irradiance

As a function of the irradiance incident on the PV cells, their characteristic curve V-I changes as shown in Figure 2.11. When the irradiance decreases, the generated PV current decreases proportionally, whereas the variation of the no-load voltage is very small.

As a matter of fact, conversion efficiency is not influenced by the variation of the irradiance within the standard operation range of the cells, which means that the conversion efficiency is the same both in a clear as well as in a cloudy day. Therefore, the smaller power generated with a cloudy sky can be referred not to a drop of efficiency, but to a reduced production of current because of lower solar irradiance.

Figure 2.11

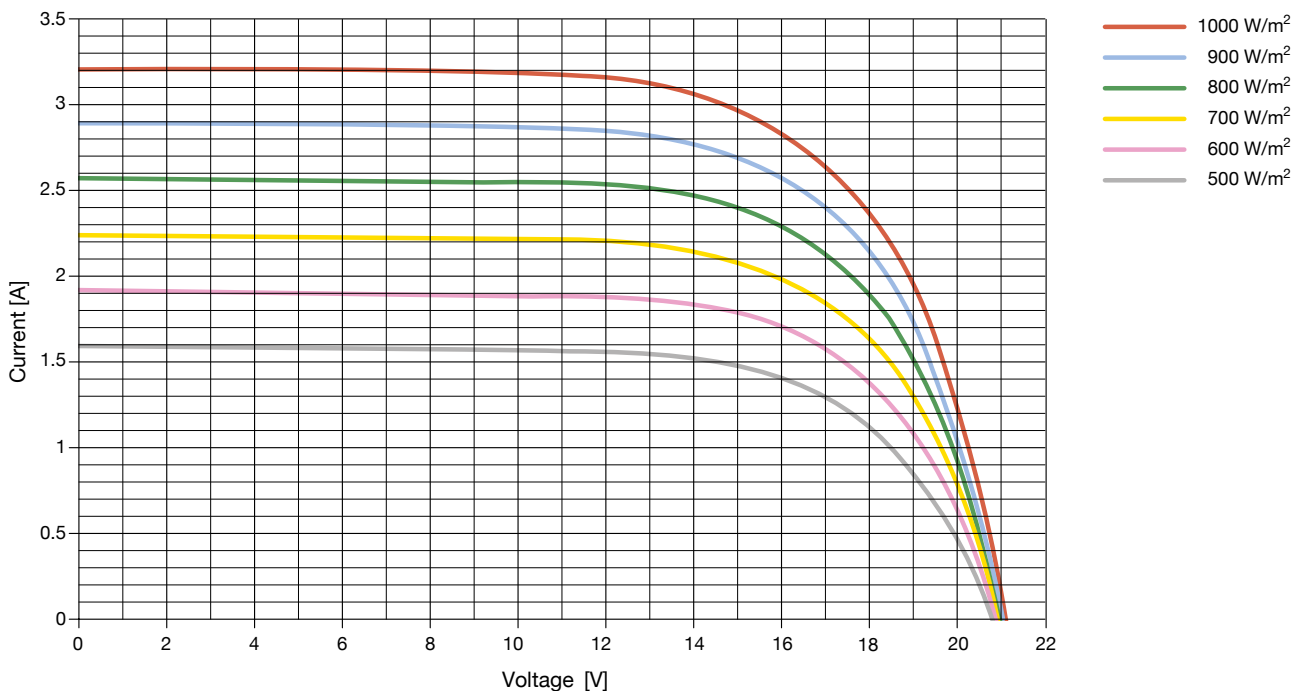

2.8.2 Temperature of the modules

Contrary to the previous case, when the temperature of the PV modules increases, the current produced remains practically unchanged, whereas the voltage decreases and with it there is a reduction in the performances of the panels in terms of produced electric power (Figure 2.12).

Figure 2.12

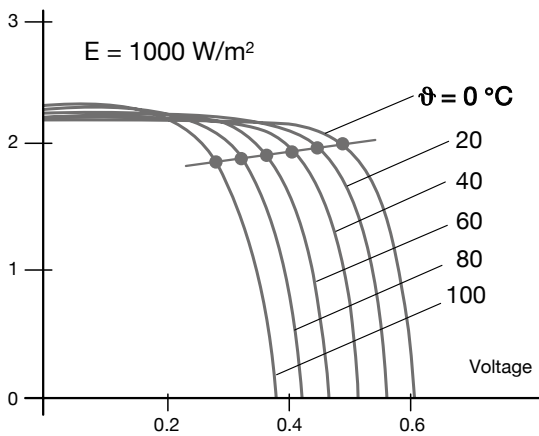

The variation in the open circuit voltage V_{oc} of a PV module, with respect to the standard conditions $V_{oc,STC}$, as a function of the operating temperature of the cells T_{cell} , is expressed by the following formula:

$$V_{oc}(T) = V_{oc,STC} - N_s \cdot \beta \cdot (25 - T_{cell}) \quad [2.13]$$

where:

β is the variation coefficient of the voltage according to temperature and depends on the typology of PV module (usually $-2.2 \text{ mV}/^\circ\text{C}/\text{cell}$ for crystalline silicon modules and about $-1.5 \div -1.8 \text{ mV}/^\circ\text{C}/\text{cell}$ for thin film modules); N_s is the number of cells in series in the module.

Therefore, to avoid an excessive reduction in the performances, it is opportune to keep under control the service temperature trying to give the modules good ventilation to limit the temperature variation on them. In this way it is possible to reduce the loss of energy due to the temperature (in comparison with the temperature of 25°C of the standard conditions) to a value around 7%⁷.

⁷ The efficiency reduction when the temperature increases can be estimated as 0.4 to 0.6 each $^\circ\text{C}$ degree.

2.8.3 Shading

Taking into consideration the area occupied by the modules of a PV plant, part of them (one or more cells) may be shaded by trees, fallen leaves, chimneys, clouds or by PV modules installed nearby.

In case of shading, a PV cell consisting in a junction P-N stops producing energy and becomes a passive load. This cell behaves as a diode which blocks the current produced by the other cells connected in series and thus jeopardizes the whole production of the module.

Besides, the diode is subject to the voltage of the other cells; this may cause the perforation of the junction because of localized overheating (hot spot), and damages to the module.

In order to avoid that one or more shaded cells thwart the production of a whole string, some diodes which by-pass the shaded or damaged part of module are inserted at the module level.

Thus, functioning of the module is guaranteed but with reduced efficiency. In theory, it would be necessary to insert a by-pass diode in parallel to each single cell, but this would be too onerous for the ratio costs/benefits. Therefore, 2 to 4 by-pass diodes are usually installed for each module (Figure 2.13).

Figure 2.13

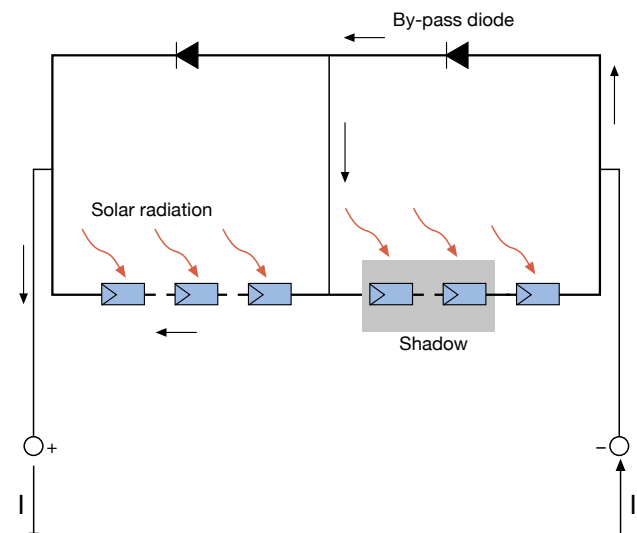

3 Installation methods and configurations

3.1 Architectural integration

In the last years the architectural integration of modules into building structures has been making great strides thanks to the manufacturing of the modules themselves, which for dimensions and characteristics can completely substitute some components.

Three macro-typologies of architectural integration for PV installations can be defined:

- 1 non-integrated plants;
- 2 partially integrated plants;
- 3 integrated plants.

Non-integrated plants are plants with ground-mounted modules, that is with the modules positioned on the elements of street furniture, on the external surfaces of building envelopes, on buildings and structures for any function and purpose with modes different from those provided for the typologies 2) and 3) (Figure 3.1)

Figure 3.1



Partially integrated plants are plants in which the modules are positioned in compliance with the typologies listed in Table 3.1, on elements of street furniture, on the external surfaces of building envelopes, on buildings and structures for any function and purpose without replacing the building materials of structures themselves (Figure 3.2). The modules are installed so as to be coplanar to the tangential plane or to the tangential planes of the roof up to a limited height.

Figure 3.2



Table 3.1

1	PV modules installed on flat roofs, that is on roof coverings with slopes up to 5°
2	PV modules installed on pitched roofs
3	PV modules installed on roofs having characteristics different from those at items 1 and 2
4	PV modules installed as sunbreakers

A plant with *architectural integration* is the plant in which the modules replace, either totally or in part, the function of the architectural elements in the buildings, elements as coverings, vertical opaque surfaces, transparent or semi-transparent surfaces on coverings, surfaces that can be opened and similar (doors, windows and shop windows, even if they cannot be opened, including frames). As a consequence, the modules are designed and realized not only to carry out the function of producing electric power, but also have architectural functions, such as protection or thermal regulation in the building (the modules must guarantee the fulfillment of energy demand of the building and have a thermal transmittance comparable to that of the replaced architectural component), water resistance and the consequent waterproofing of the underlying structure of the building and mechanical withstand comparable to that of the replaced element (Figure 3.3).

Figure 3.3



3.2 PV plant layout

The connection of the strings forming the solar field of the PV plant can chiefly occur by providing:

- one single inverter for the whole plant (single-inverter or central inverter) (Figure 3.4)
- one inverter for each string (Figure 3.5)
- one inverter for more strings (multi-inverter plant) (Figure 3.6).

3.2.1 Single-inverter plant

This layout is used in small plants and with modules of the same type having the same exposition.

There are economic advantages deriving from the presence of one single inverter, in terms of reduction of the initial investment and of maintenance costs. However, a failure of the single inverter causes the stoppage of the production of the whole plant.

Besides, this solution is not very suitable as the size of the PV plant (and with it also the peak power) increases, since this raises the problems of protection against overcurrents and the problems deriving from a different shading, that is when the exposition of the panels is not the same in the whole plant.

The inverter regulates its functioning through the MPPT, taking into account the average parameters of the strings connected to the inverter; therefore, if all the strings are connected to a single inverter, the shading or the failure of one or part of them involves a higher reduction in the electrical performances of the plant in comparison with the other layouts.

Figure 3.4

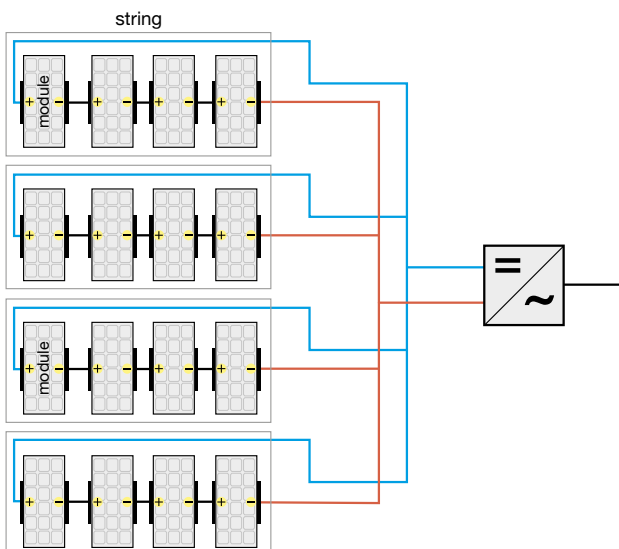

3.2.2 Plant with one inverter for each string

In a medium-size plant, each string may be directly connected to its own inverter and thus it operates according to its own maximum power point.

With this layout, the blocking diode, which prevents the source direction from being reverse, is usually included in the inverter, the diagnosis on production is carried out directly by the inverter, which moreover can provide for the protection against the overcurrents and overvoltages of atmospheric origin on the DC side.

Besides, having an inverter on each string limits the coupling problems between modules and inverters and the reduction in the performances caused by shading or different exposition.

Moreover, in different strings, modules with different characteristics may be used, thus increasing the efficiency and reliability of the whole plant.

Figure 3.5

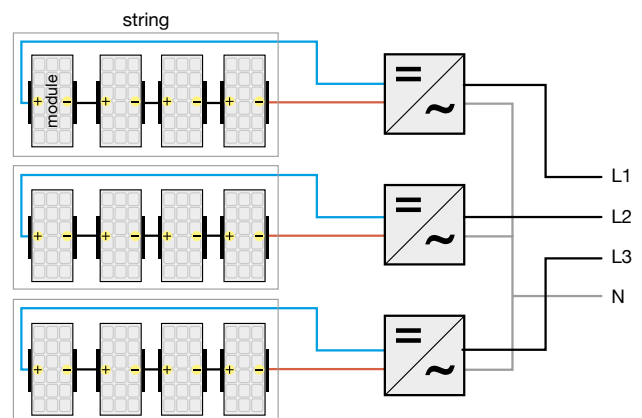

3.2.3 Multi-inverter plant

In large-size plants, the PV field is generally divided into more parts (subfields), each of them served by an inverter of one's own to which different strings in parallel are connected.

In comparison with the layout previously described, in this case, there is a smaller number of inverter with a consequent reduction of the investment and maintenance costs.

However, the benefit of the reduction in the problems due to shading, different exposition of the strings and also to the use of modules different from one another remains, provided that the subfield strings with equal modules and with equal exposition are connected to the same inverter. Besides, the failure of an inverter does not involve the loss of production of the whole plant (as in the case of single-inverter), but of the relevant subfield only.

¹ See Chapter 1

It is advisable that each string can be disconnected separately², so that the necessary operation and maintenance verifications can be carried out without putting out of service the whole PV generator.

When installing paralleling switchboard on the DC side, it is necessary to provide for the insertion on each string of a device for the protection against overcurrents and reverse currents so that the supply of shaded or faulted strings from the other ones in parallel is avoided. Protection against overcurrents can be obtained by means of either a thermomagnetic circuit-breaker or a fuse, whereas protection against reverse current is obtained through blocking diodes³.

With this configuration the diagnosis of the plant is assigned to a supervision system which checks the production of the different strings.

Figure 3.6

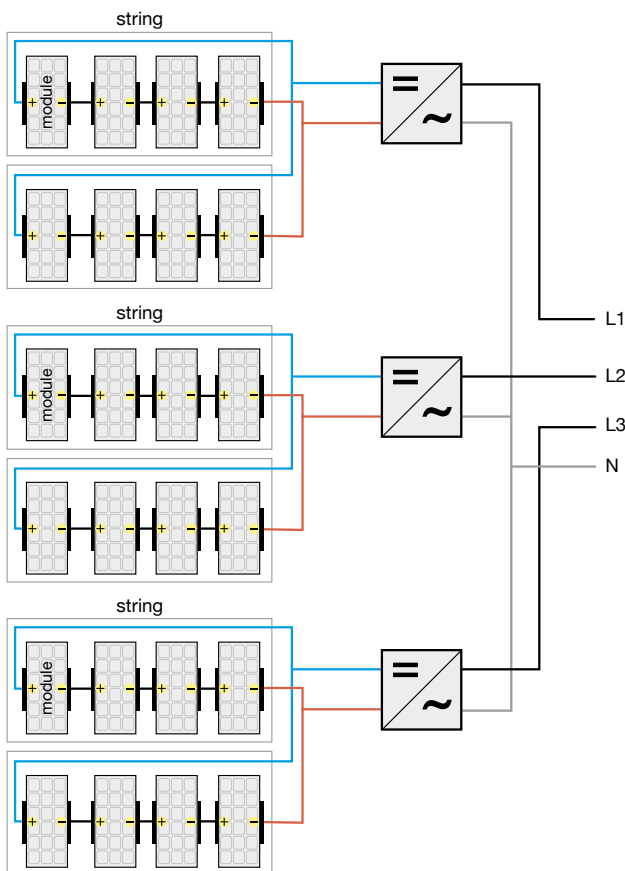

² Note that the opening of the disconnecting device does not exclude that the voltage is still present on the DC side.

³ The diodes introduce a constant power loss due to the voltage drop on their junction. Such loss can be reduced through the use of components with semiconducting metal junction having a loss of 0.4V (Schottky diodes), instead of 0.7V as conventional diodes.

3.3 Selection and interfacing of inverters

The selection of the inverter and of its size is carried out according to the PV rated power it has to manage. The size of the inverter can be determined starting from a value from 0.8 to 0.9 for the ratio between the active power put into the network and the rated power of the PV generator.

This ratio keeps into account the loss of power of the PV modules under the real operating conditions (working temperature, voltage drops on the electrical connections...) and the efficiency of the inverter.

This ratio depends also on the methods of installation of the modules (latitude, inclination, ambient temperature...) which may cause a variation in the generated power. For this reason, the inverter is provided with an automatic limitation of the supplied power to get round situations in which the generated power is higher than that usually estimated

Among the characteristics for the correct sizing of the inverter, the following ones should be considered:

- DC side:
 - rated power and maximum power;
 - rated voltage and maximum admitted voltage;
 - variation field of the MPPT voltage under standard operating conditions;
- AC side:
 - rated power and maximum power which can be continually delivered by the conversion group, as well as the field of ambient temperature at which such power can be supplied;
 - rated current supplied;
 - maximum delivered current allowing the calculation of the contribution of the PV plant to the short-circuit current;
 - maximum voltage distortion and power factor;
 - maximum conversion efficiency;
 - efficiency at partial load and at 100% of the rated power ("European efficiency"⁴ or efficiency diagram⁵ (Figure 3.7)).

⁴ The European efficiency is calculated by considering the efficiencies at partial load of the inverter according to the formula:

$$\eta_{\text{euro}} = 0.03 \cdot \eta_{5\%} + 0.06 \cdot \eta_{10\%} + 0.13 \cdot \eta_{20\%} + 0.10 \cdot \eta_{30\%} + 0.48 \cdot \eta_{50\%} + 0.20 \cdot \eta_{100\%}$$

⁵ From this diagram it is possible to see that the maximum efficiency ranges from 40% to 80% of the rated power of the inverter, which corresponds to the power interval in which the inverter works for the most part of the operating time.

Figure 3.7

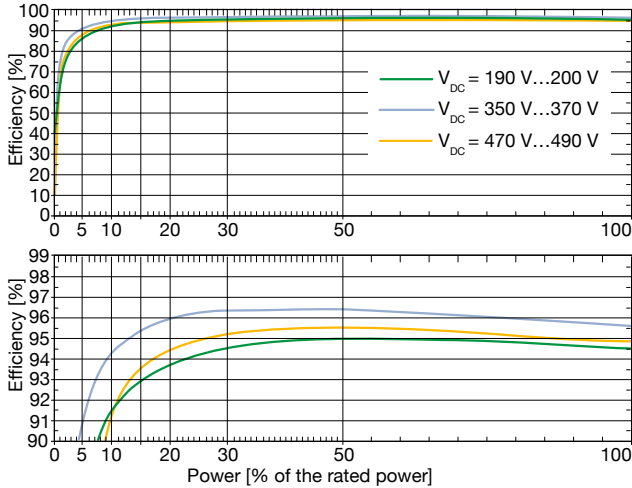

Moreover, it is necessary to evaluate the rated values of voltage and frequency at the output and of voltage at the input of the inverter.

The voltage and frequency values at the output, for plants connected to the public distribution network are imposed by the network with defined tolerances⁶.

As regards the voltage at the input, the extreme operating conditions of the PV generator shall be assessed in order to ensure a safe and productive operation of the inverter. First of all it is necessary to verify that the open circuit voltage U_{oc} ⁷ at the output of the strings, at the lowest expected operating temperature, is lower than the maximum temperature which the inverter can withstand, that is:

$$U_{oc\ max} \leq U_{MAX} \quad [3.1]$$

In some models of inverter there is a capacitor bank at the input; as a consequence, the insertion into the PV field generates an inrush current equal to the sum of the short-circuit currents of all the connected strings and this current must not make the internal protections, if any, trip.

Each inverter is characterized by a normal operation range of voltages at the input. Since the voltage at the output of the PV modules is a function of the temperature, it is necessary to verify that under the predictable service conditions, the inverter operates within the voltage range declared by the manufacturer. As a consequence, the two inequalities [3.2] and [3.3] must be simultaneously verified:

$$U_{min} \geq U_{MPPT\ min} \quad [3.2]$$

⁶ Since 2008 the European standardized voltage should be 230/400V with +6% and -10% tolerance, while the tolerance on frequency is ± 0.3 Hz.

⁷ U_{oc} is considered at standard test conditions. As regards the selection of the inverter and of the other components of the PV plant on the DC side, a precautionary PV array maximum voltage as calculated in IEC TS 62548 can be assumed.

that is, the minimum voltage, at the corresponding maximum power at the output of the string and under standard solar radiation conditions, shall exceed the minimum operating voltage of the MPPT of the inverter; this voltage keeps the control logic active and permits a correct power delivery into the distributor's network. Besides, it shall be:

$$U_{max} \leq U_{MPPT\ max} \quad [3.3]$$

that is, the maximum voltage, at the corresponding maximum power at the output of the string and under standard solar radiation conditions, shall be lower than or equal to the maximum operating voltage of the MPPT of the inverter.

Figure 3.8 shows a coupling diagram between PV field and inverter, taking into account the three above mentioned inequalities.

In addition to compliance with the three above mentioned conditions regarding voltage, it is necessary to verify that the maximum current of the PV generator when operating at the maximum power point (MPP) is lower than the maximum current admitted by the inverter at the input.

Figure 3.8

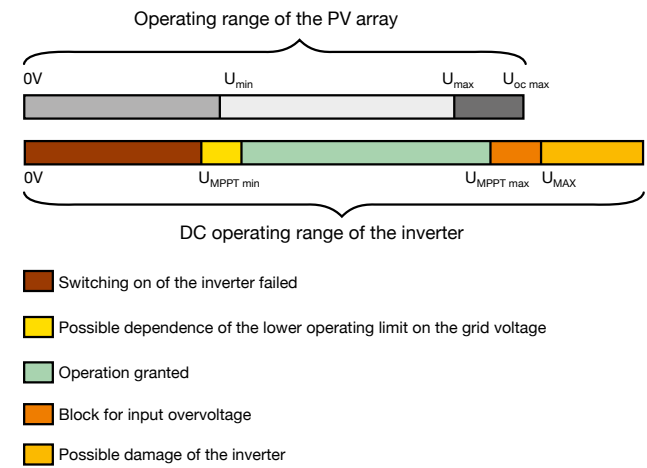

Caption:

- U_{min} voltage of the PV array with standard irradiance, in correspondence with the maximum operating temperature expected for the PV modules at the installation site
- U_{max} voltage of the PV array with standard irradiance, in correspondence with the minimum operating temperature expected for the PV modules at the installation site
- $U_{oc\ max}$ open circuit voltage of the PV array, in correspondence with the minimum operating temperature expected for the PV modules at the installation site
- $U_{MPPT\ min}$ minimum input operating voltage admitted by the inverter
- $U_{MPPT\ max}$ maximum input operating voltage admitted by the inverter
- U_{MAX} maximum input voltage which can be withstood by the inverter

The inverters available on the market have a rated power up to about 10 kW single-phase and about 100 kW three-phase.

In small-size plants up to 6 kW with single-phase connection to the LV network, a single inverter is usually installed, whereas in plants over 6 kW with three-phase connection to the LV or MV grid, more inverters are usually installed. In small/medium-size plants it is usually preferred the

solution with more single-phase inverters equally distributed on the three phases, common neutral and with a single transformer for the separation from the public network (Figure 3.9).

Instead, for medium- and large-size plants it is usually convenient to have a structure with few three-phase inverters to which several strings are connected in parallel on the DC side in the PV string combiner boxes (Figure 3.10).

Figure 3.9

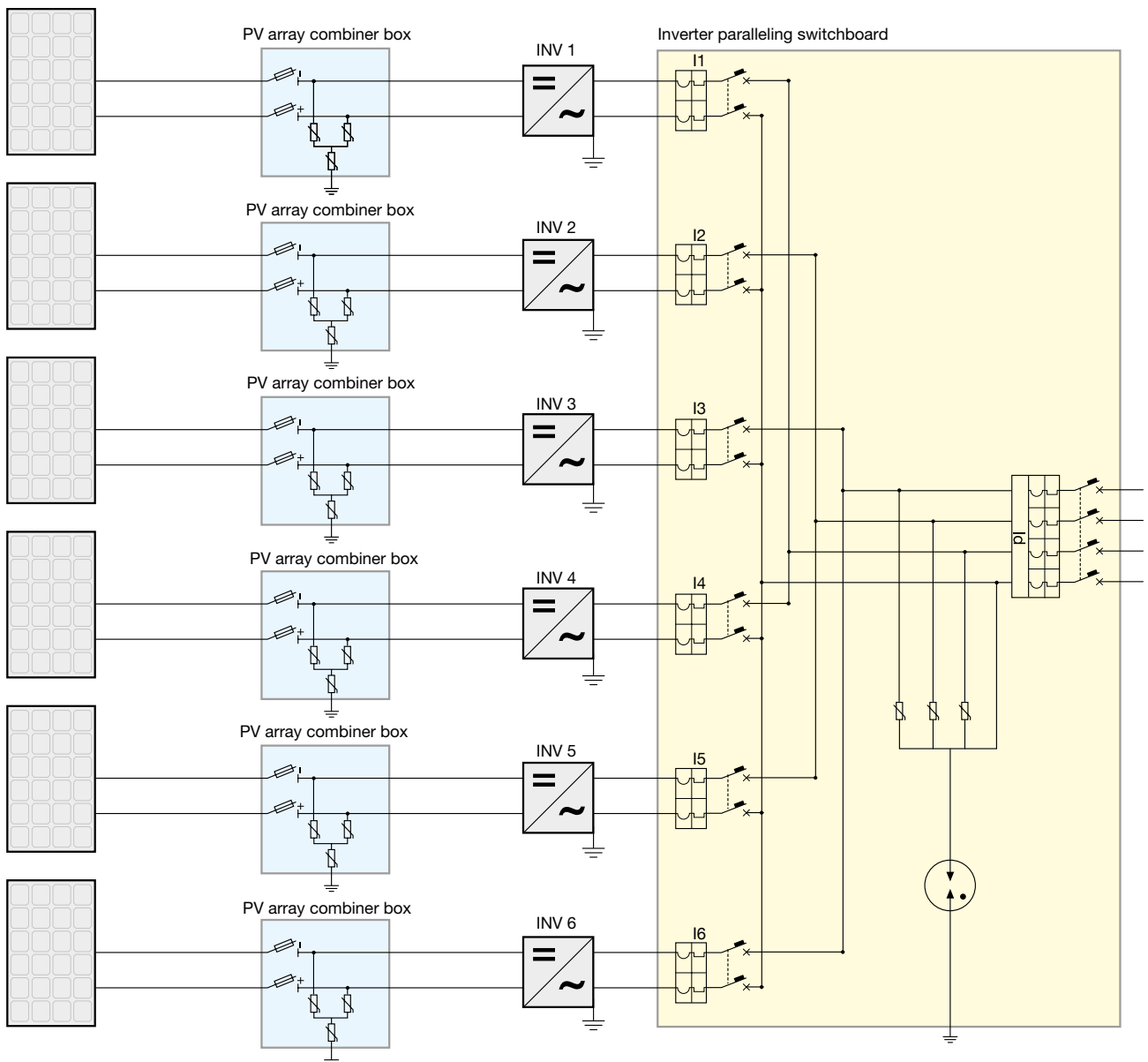
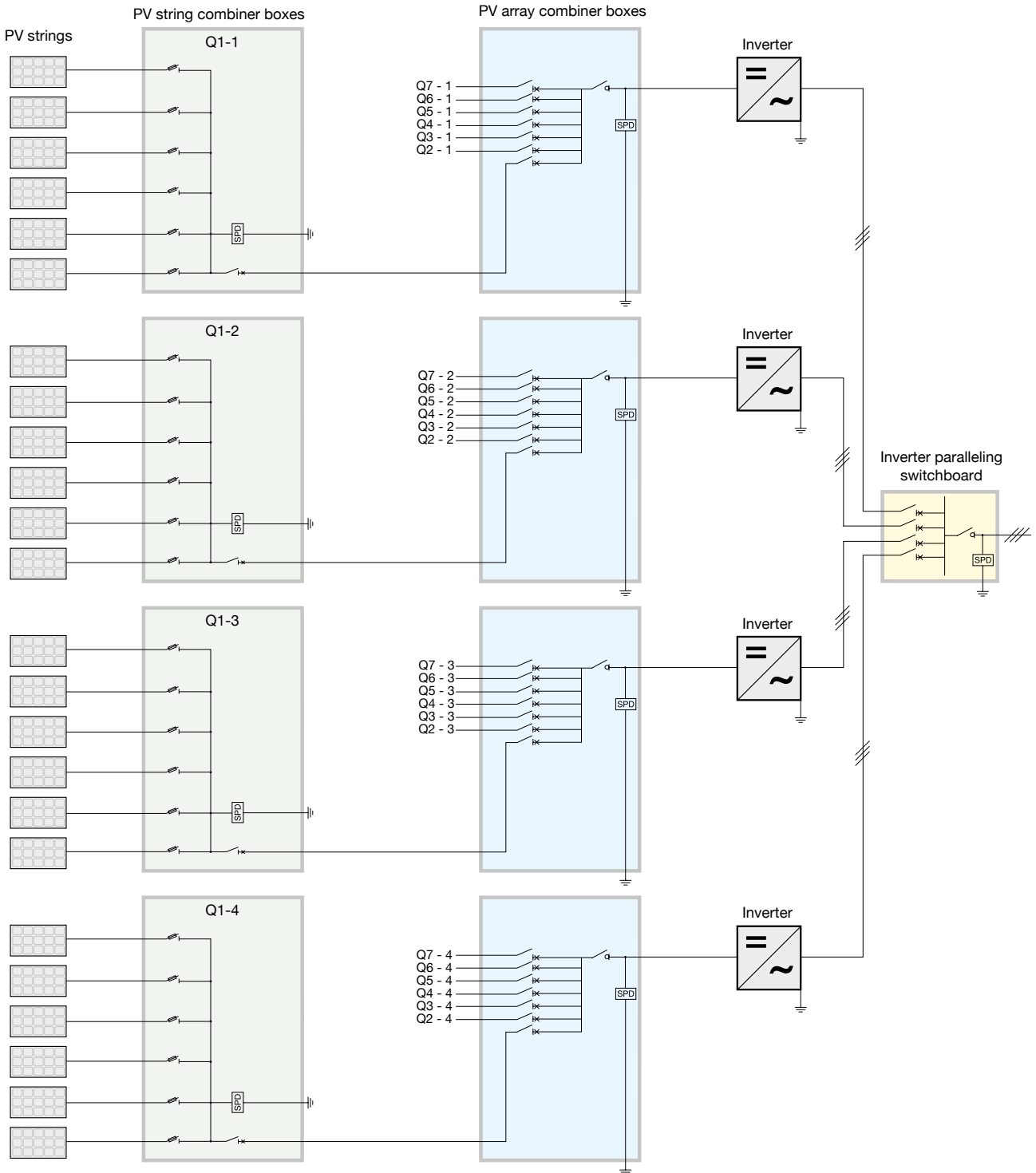

Figure 3.10



The disconnection of the inverter must be possible both on the DC side as well as on the AC side so that maintenance is allowed by excluding both the supply sources, that is PV generator and grid.

Besides, as shown in Figure 3.10, it is advisable to install a disconnecting device on each string, so that verification and maintenance operations on each string are possible without putting out of service the other parts of the plant.

3.4 Choice of cables

The cables used in a PV plant must be able to stand, for the whole life cycle (20 to 25 years) of the plant, severe environmental conditions in terms of high temperatures, atmospheric precipitations and ultraviolet radiations.

First of all, the cables shall have a rated voltage suitable for that of the plant. Under direct current conditions, the plant voltage shall not exceed of 50% the rated voltage of the cables (Figure 3.11) referred to their AC applications (in alternating current the voltage of the plant shall not exceed the rated voltage of the cables).

Table 3.2

alternating current (V)	direct current (V)
300/500	450/750
450/750	675/1125
600/1000	900/1500

3.4.1 Types of cables

The conductors⁸ on the DC side of the plant shall have double or reinforced isolation (class II) so as to minimize the risk of earth faults and short-circuits (IEC 60364-712).

The cables on the DC side are divided into:

- *solar cables (or string cables)*, which connect the modules to the string of the first PV string combiner box or directly to the inverter
- *non-solar cables*, which are used on the load side of the first switchboard.

The cables connecting the modules are fastened in the rear part of the modules themselves, where the temperature may reach 70° to 80°C. As a consequence, these cables shall be able to stand high temperatures and withstand ultraviolet rays, when installed at sight. Therefore, particular cables are used, generally single-core cables with rubber sheath and isolation, rated voltage 0.6/1kV, with maximum operating temperature not lower than 90°C and with high resistance to UV rays.

Non-solar cables positioned on the load side of the first switchboard are at an environmental temperature not higher than 30° to 40°C since they are far away from the modules.

These cables cannot withstand UV rays and therefore, if laid out outside, they must be protected against solar radiation in conduit or trunking and however sheathed for outdoor use. On the contrary, if they are laid out inside the buildings, the rules usually applied to electrical plants are valid.

For cables erected on the AC side downstream the inverter what said for non-solar cables on the DC side is valid.

⁸ The whole of cables and conduit or trunking system in which they are placed.

3.4.2 Cross sectional area and current carrying capacity

The cross sectional area of a cable shall be such as that:

- its current carrying capacity I_z is not lower than the design current I_b ;
- the voltage drop at its end is within the fixed limits.

Under normal service conditions, each module supplies a current near to the short-circuit one, so that the service current for the string circuit is assumed to be equal to:

$$I_b = 1.25 \cdot I_{SC} \quad [3.4]$$

where I_{SC} is the short-circuit current under standard test conditions and the 25% rise takes into account radiation values higher than 1kW/m^2 .

When the PV plant is large-sized and divided into sub-arrays, the PV sub-array cables shall carry a design current equal to:

$$I_b = S_{SA} \cdot 1.25 \cdot I_{SC} \quad [3.5]$$

where S_{SA} is the number of strings of the sub-array relating to the same PV string combiner box.

The current carrying capacity I_o of the cables is usually stated by the manufacturers at 30°C in free air. To take into account also the methods of installation and the temperature conditions, the current carrying capacity I_o shall be reduced by a correction factor (when not declared by the manufacturer) equal to⁹:

- $k_1 = 0.58 \cdot 0.9 = 0.52$ for solar cables
- $k_2 = 0.58 \cdot 0.91 = 0.53$ for non-solar cables.

The factor 0.58 considers the installation on the rear of the modules where the ambient temperature reaches 70°C ¹⁰, the factor 0.9 the installation of solar cables in conduit or trunking system, while the factor 0.91 refers to the installation of non-solar cables into conduit exposed to sun.

In PV plants the accepted voltage drop is 1% to 2% (instead of the usual 4% of the user plants) so that the loss of energy produced due to the Joule effect on the cables¹¹ is limited as much as possible.

⁹ The resulting carrying capacity must be multiplied also by a second reduction coefficient, as it usually happens, which considers the installation in bunch into the same conduit or trunking system.

¹⁰ At 70°C ambient temperature and assuming a maximum service temperature for the insulating material equal to 90°C it results:

$$\sqrt{\frac{\theta_{\max} - 0}{\theta_{\max} - 0_0}} = \sqrt{\frac{90 - 70}{90 - 30}} = \sqrt{\frac{1}{3}} = 0.58$$

¹¹ On the DC side the voltage drop in the cables is purely resistive and in percentage it corresponds to the power loss:

$$\Delta U\% = \frac{\Delta U}{U_n} = \frac{\Delta U \cdot I_n}{U_n \cdot I_n} = \frac{\Delta P}{P_n} = \Delta P\%$$

4 Protection against overcurrents and overvoltages

When defining the layout of a photovoltaic plant it is necessary to provide, where needed, for the protection of the different sections of the plant against overcurrents and overvoltages of atmospheric origin.

Here are given, firstly, the conditions for the protection against overcurrents in the PV plant on the supply (DC side) and on the load side of the inverter (AC side), then the methods for the protection of the plant against any damage caused by possible direct or indirect lightning¹.

4.1 Protection against overcurrents on DC side

4.1.1 Cable protections

From the point of view of protection against overloads, it is not necessary to protect PV string cables if they are chosen with a current carrying capacity equal to or greater than $1.25 \cdot I_{sc}^2$; it is not necessary to protect PV sub-array cables if they are chosen with a current carrying capacity equal to or greater than $1.25 \cdot S_{SA} \cdot I_{sc}$; it is not necessary to protect the PV array cable if it is chosen with a current carrying capacity equal to or greater than $1.25 \cdot S_A \cdot I_{sc}$ (IEC 60364-7).

As regards short-circuits, the cables on the DC side are affected by such overcurrent in case of:

- fault between the polarity of the PV system;
- fault to earth in the earthed systems;
- double fault to earth in the earth-insulated systems.

A short-circuit on a PV string cable (fault 1 of Figure 4.1) is supplied simultaneously upstream by the string under consideration ($I_{sc1} = 1.25 \cdot I_{sc}$) and downstream by the other $S_A - 1$ strings connected to the same inverter ($I_{sc2} = (S_A - 1) \cdot 1.25 \cdot I_{sc}$). In case of a small-sized PV plant with two strings only ($S_A = 2$), it results that $I_{sc2} = 1.25 \cdot I_{sc} = I_{sc1}$ and therefore it is not necessary to protect the PV string cables against short-circuit.

On the contrary, when three or more strings ($S_A \geq 3$) are connected to the inverter, the current I_{sc2} is higher than the service current and therefore the cables must be protected against the short-circuit when their current carrying capacity is lower than I_{sc2} , that is $I_z < (S_A - 1) \cdot 1.25 \cdot I_{sc}$.

A short-circuit between a PV string combiner box and the PV array combiner box (fault 2 of Figure 4.1) is supplied upstream by the PV sub-array strings S_{SA} in parallel (I_{sc3}) and downstream by the remaining ($S_A - S_{SA}$) strings relevant to the same PV array combiner box.

The short-circuit current $I_{sc3} = S_{SA} \cdot 1.25 \cdot I_{sc}$ coincides with the service current of the circuit between the PV string combiner box and the PV array combiner box, whereas the current $I_{sc4} = (S_A - S_{SA}) \cdot 1.25 \cdot I_{sc}$ is higher than the service current if $S_A - S_{SA} > S_{SA} \Rightarrow S_A > 2S_{SA}$. In this case, it is necessary to protect the cable against short-circuit if its current carrying capacity is lower than I_{sc4} , that is $I_z < (S_A - S_{SA}) \cdot 1.25 \cdot I_{sc}$.

Figure 4.1

“A” represents the protective device installed in the PV string combiner box.
 “B” represents the protective device installed in the PV array combiner box.
 “ S_{SA} ” is the number of parallel-connected PV strings in the PV sub-array.
 “ S_A ” is the total number of parallel-connected PV strings in the PV sub-array.

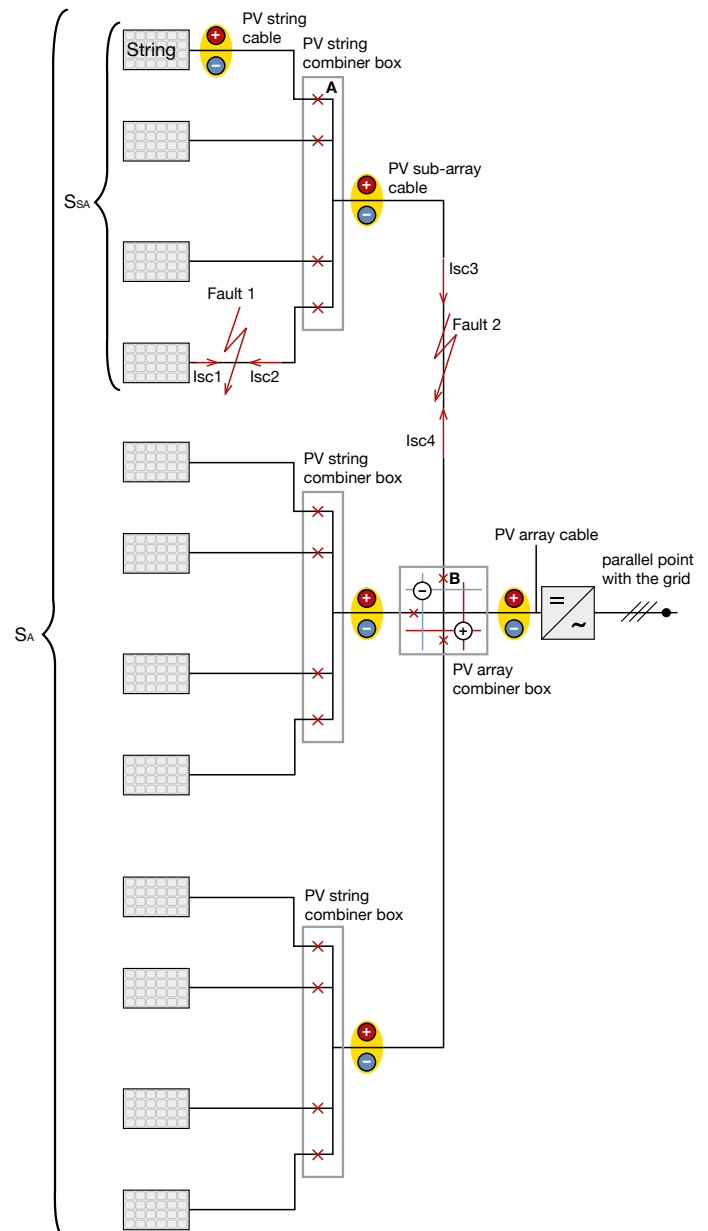

¹ As regards power factor correction of a user plant in the presence of a PV plant see Annex E of the Technical Application Paper N. 8

² I_{sc} is the short-circuit current in the module under standard test conditions and the 25% rise takes into account of the insolation values exceeding $1kW/m^2$ (see Chapter 3).

4.1.2 Protection of strings against reverse current

Due to shading or faults a string becomes passive absorbing and dissipating the electric power generated by the other strings connected in parallel to the same inverter through a current which flows through the string under consideration in reverse direction with respect to that of standard operation, with possible damages to the modules.

Since with S_A strings in parallel connected to the same inverter the highest reverse current is equal to $I_{rev} = (S_A - 1) \cdot I_{sc}$, it is not necessary to protect the strings if $I_{rev} < I_{MOD_MAX_OCPR}$ (IEC TS 62548), where $I_{MOD_MAX_OCPR}$ is the PV module maximum overcurrent protection rating determined by IEC 61730-2³.

4.1.3 Contribution of the inverter

The contribution to short-circuit on the DC side of the inverter may come from the grid and from the discharge of the capacitors inside the inverter.

The grid short-circuit current is due to the free-wheeling diodes of the inverter which in this case act as a bridge rectifier. Such current is limited by the impedances of the transformer and of the inductors belonging to the output circuit. This current exists in case of inverter with galvanic insulation at 50Hz, while it is null in case of inverter without transformer. In fact, these inverters usually have an input DC/DC converter so that the operation of the PV generator on a wide voltage range is guaranteed; such converter, due to its constructive typology, includes at least one blocking diode which prevents the grid current from contributing to the short-circuit.

The discharge current of the capacitors is limited by the cables between inverter and fault and exhausts itself with exponential trend: the lowest the impedance of the cable stretch, the highest the initial current, but the lowest the time constant of the discharge. The energy which flows is limited to that one initially stored in the capacitors. Moreover, if a blocking diode or another similar device is in series with one of the two poles, this contribution to short-circuit is null.

However, a case-by-case evaluation is necessary: in particular, a very high discharge current of the capacitors, associated to long time constants, could require an increase in the breaking capacity of the circuit-breakers.

4.1.4 Choice of protective devices

As regards the protection against the short-circuits on the DC side, the devices must be obviously suitable for DC usage; moreover they shall have a rated service voltage U_e equal or higher than the PV array maximum voltage, equal to U_{oc} ⁴ corrected for the lowest expected operating temperature (IEC TS 62548). Correction of the voltage for the lowest expected operating temperature shall be calculated according to manufacturer's instructions. Where manufacturer's instructions are not available for crystalline and multi-crystalline silicon modules, U_{oc} shall be multiplied by a correction factor according to Table 5 of IEC TS 62548 using the lowest expected operating temperature as a reference. Where the lowest expected ambient temperature is below -40 °C, or where technologies other than crystalline or multi-crystalline silicon are in use, voltage correction shall only be made in accordance with manufacturer's instructions.

Where string overcurrent protection is required, either (IEC TS 62548)⁵:

- a) each PV string shall be protected with an overcurrent protection device, where the nominal overcurrent protection rating of the string overcurrent protection device shall be I_n where:

$$1.5 \cdot I_{sc} < I_n < 2.4 \cdot I_{sc} \text{ and } I_n \leq I_{MOD_MAX_OCPR} \quad [4.1]$$

or

- b) strings may be grouped in parallel under the protection of one overcurrent device provided:

$$1.5 \cdot S_G \cdot I_{sc} < I_{ng} < I_{MOD_MAX_OCPR} - ((S_G - 1) \cdot I_{sc}) \quad [4.2]$$

where:

S_G is the number of strings in a group under the protection of the one overcurrent device;

I_{ng} is the nominal overcurrent protection rating of the group overcurrent protection device.

Strings can generally be grouped only under one overcurrent protection device if $I_{MOD_MAX_OCPR}$ is greater than $4 I_{sc}$. Where circuit breakers are used as overcurrent protection device these may also fulfil the role of a disconnecter.

The nominal rated current (I_n) of overcurrent protection devices for PV sub-arrays shall be determined with the following formula (IEC TS 62548):

$$1.25 \cdot S_{SA} \cdot I_{sc} < I_n < 2.4 \cdot S_{SA} \cdot I_{sc} \quad [4.3]$$

The 1.25 multiplier used here instead of the 1.5 multiplier

³ In some countries blocking diodes are permitted as a replacement for overcurrent protection (IEC TS 62548). In other countries diodes are not considered reliable enough to replace overcurrent protection because their failure mode is generally to a short-circuited state when subjected to voltage transients. Local country requirements should be taken into account in system designs. However, if used, blocking diodes shall have a voltage rating at least 2 x the PV array maximum voltage and the current rating at least $1.4 \cdot I_{sc}$ for PV strings, $1.4 \cdot S_{SA} \cdot I_{sc}$ for PV sub-arrays and $1.4 \cdot S_A \cdot I_{sc}$ for PV arrays.

⁴ U_{oc} is the open circuit voltage out of the strings (see Chapter 3).

⁵ For thermomagnetic moulded-case circuit-breakers I_n is used instead of I_n or I_{ng} .

used for strings is to allow designer flexibility.

The PV array overcurrent protection is only required for systems connected to batteries or where other sources of current may feed into the PV array under fault conditions. The rated current (I_n) of PV array overcurrent protection devices shall be (IEC TS 62548):

$$1.25 \cdot S_A \cdot I_{sc} < I_n < 2.4 \cdot S_A \cdot I_{sc} \quad [4.4]$$

The PV array overcurrent protection devices are commonly installed between the battery or batteries and the charge controller as close as possible to the battery or batteries. If these devices are appropriately rated, they provide protection to both, the charge controller and the PV array cable. In such cases, no further PV array cable overcurrent protection between the PV array and the charge controller is required.

Despite the easy usage of fuses, attention must be paid to the sizing and choice of such devices, which shall not only have rated current given by the previous formulas, but also tripping characteristic type gPV (IEC 60269-6), shall be inserted into suitable fuse holders and be able to dissipate the power generated under the worst operating conditions.

To the purpose of protection for the connection cables⁶, the protective device must be chosen so that the following relation is satisfied for each value of short-circuit (IEC 60364) up to a maximum prospective short-circuit current:

$$(I^2t) \leq K^2 S^2 \quad [4.5]$$

where:

(I^2t) is the Joule integral for the short-circuit duration (in A^2s); K is a characteristic constant of the cable, depending on the type of conductor and isolating material;

S is the cross-sectional area of the cable (in mm^2).

The rated ultimate short-circuit breaking capacity of the devices in the PV string combiner box must not be lower than the short-circuit current of the other S_A-1 strings for the case a), that is⁷:

$$I_{cu} \geq (S_A - 1) \cdot 1.25 \cdot I_{sc} \quad [4.6]$$

or than the short-circuit current of the other S_A-S_G strings for the case b), that is:

$$I_{cu} \geq (S_A - S_G) \cdot 1.25 \cdot I_{sc} \quad [4.7]$$

The devices in the PV array combiner box must protect against short-circuit the sub-array cables when these cables have a current carrying capacity lower than $I_{sc4} = (S_A - S_{SA}) \cdot 1.25 \cdot I_{sc}$ ⁸ (figure 4.1). In such case, these devices shall satisfy the relation [4.3], while their rated ultimate short-circuit breaking capacity shall not be

lower than the short-circuit current of the other S_A-S_{SA} strings, that is:

$$I_{cu} \geq (S_A - S_{SA}) \cdot 1.25 \cdot I_{sc} \quad [4.8]$$

Moreover, overcurrent protection devices shall be placed (IEC TS 62548):

- for string overcurrent protection devices, they shall be where the string cables join the sub-array or array cables in the string combiner box;
- for sub-array overcurrent protection devices, they shall be where the sub-array cables join the array cables in the array combiner box;
- for array overcurrent protection devices, they shall be where the array cables join the power conversion equipment.

The location of the overcurrent protection devices at the end of those cables which are furthest away from the PV sub-array or string is to protect the system and wiring from fault currents flowing from other sections of the PV array or from other sources such as batteries.

4.2 Protection against overcurrents on AC side

Since the cable connecting the inverter to the point of parallel with the grid is usually dimensioned to obtain a current carrying capacity higher than the maximum current which the inverter can deliver, a protection against overload is not needed. However, the cable must be protected against a short circuit supplied by the grid⁹ through a protective device positioned near the point of parallel with the grid. To protect such cable, the main circuit-breaker of the consumer plant can be used if the specific let-through energy is withstood by the cable. However, the trip of the main circuit-breaker put all the consumer plant out of service. In multi-inverter plants, (Figure 4.2), the presence of one protection for each line ensures, in case of fault on an inverter, the functioning of the other ones, provided that the circuit-breakers on each line are selective with the main circuit-breaker.

Figure 4.2

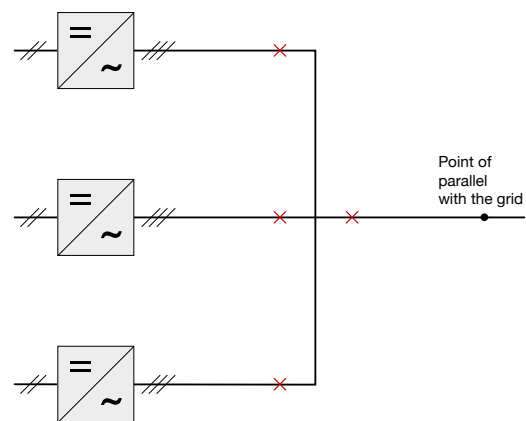

⁶ Protection against short-circuit only since usually either $I_z \geq 1.25 \cdot I_{sc}$ or $I_z \geq 1.25 \cdot S_{SA} \cdot I_{sc}$ or $I_z \geq 1.25 \cdot S_A \cdot I_{sc}$.

⁷ The short-circuit current $I_{sc1} = 1.25 \cdot I_{sc}$ (Figure 4.1) is negligible since the string cable has a current carrying capacity not lower than $1.25 \cdot I_{sc}$.

⁸ The short-circuit current $I_{sc3} = S_{SA} \cdot 1.25 \cdot I_{sc}$ (Figure 4.1) is negligible since the string cable has a current carrying capacity not lower than $S_{SA} \cdot 1.25 \cdot I_{sc}$.

⁹ Generally, the inverter limits the output current to a value which is the double of its rated current and goes in stand-by in a few tenths of seconds due to the trip of the internal protection. As a consequence, the contribution of the inverter to the short-circuit current is negligible in comparison with the contribution of the grid.

4.3 Choice of switching and disconnecting devices

The installation of a disconnecting device on each string is recommended to allow verification or maintenance interventions on the string without putting out of service other parts of the PV plant¹⁰.

The disconnection of the inverter must be possible both on the DC side as well as on the AC side so that maintenance is allowed by excluding both the supply sources (grid and PV generator) (IEC 60364-7).

On the DC side of the inverter a disconnecting device shall be installed which can be switched under load, such as a switch-disconnector. On the AC side a general disconnecting device shall be provided. The protective device installed at the connection point with the grid can be used; if this device is not close to the inverter, it is advisable to position a disconnecting device immediately on the load side of the inverter.

4.4 Selection of surge protective devices (SPD) for the protection of PV plants against lightning

PV plants, which are becoming more and more widespread, very often require a protection against lightning flashes, because of their location, of their vulnerability and of their value.

The need to realize the protection must be verified by carrying out the usual risk assessment extensively described in the Std. IEC 62305-2.

The PV plants taken into consideration are both those ones installed on buildings (as covering, on facades, parapets, sunbreakers, etc.) as well as those installed on other types of building structures (e.g. greenhouses, pergolas, roofings, shelters, acoustic barriers, and temporary structures).

Hereafter in the document these types are called "PV plants on roofs". Besides, also plants installed on ground are considered; they represent the second typology and are defined as "PV plants on ground".

The purpose is to define when and which protective measures are necessary, and where and how they must be installed.

The plant is designed only for the protection of:

- the inverter, and its interface devices on the DC and AC sides
- the DC current generator
- the devices for the control and monitoring of the plant itself.

The withstand voltage of these devices must be declared by the manufacturer; here are some indicative data which represent the minimum required by the product standards:

	$U_{ocstc} \leq 213 \text{ V}$	$U_{ocstc} \leq 424 \text{ V}$	$U_{ocstc} \leq 849 \text{ V}$	$U_{ocstc} \leq 1500 \text{ V}$
PV module	2.5 kV	4 kV	6 kV	8 kV
Inverter: DC interface		2.5 kV	4 kV	6 kV
Inverter: AC interface	4 kV			

Where U_{ocstc} STC is the voltage with open circuit and measured under standard testing conditions on a PV module.

The cables to be protected against direct lightning strikes are:

- the AC supply cables from the main switchboard to the inverter
- the DC supply cables from the DC generator to the inverter
- the signaling cables connecting the sensors to the consumer unit.

Risk assessment in compliance with the Std. IEC 62305-2 shows that, as regards these applications, the risk of human losses is always lower than the tolerable risk, above all due to the limited presence of human beings, whereas, in such structure, there is always the risk of economic losses connected not only to the value of the plant components which could be damaged, but also, above all, to a possible stop of production.

When the cost for losses exceeds that of the protection measures, a protection system becomes necessary; this is very likely, when considering the high economic impact of production downtime.

However, let it be clearly understood that only the owner or the manager of the plant can define the tolerable damage frequency F_T . This definition cannot leave the above mentioned economic evaluations out.

As an indication, a typical range of values is: from one damage over a period of 20 years ($F_T = 0.05$) to one damage in 10 years ($F_T = 0.1$).

Once the value of the damage frequency has been defined and determined, it is possible, in compliance with the Std. IEC 62305-2, to select and define the size of the protection measures.

A distinction should be made between the PV plants installed on roofs and those ones on ground.

¹⁰ When an automatic circuit-breaker is used, the switching and disconnecting function is already included.

4.4.1 PV plants on roofs

In case of PV plants on roofs, the first thing to do is to calculate the collection area of the building to establish, in compliance with the Std. IEC 62305-2, whether there is the need to install an LPS¹¹.

If the installation of an LPS is not required, then it is necessary to provide for the protection of the incoming electric line, unless we find in a urban area; protection can be obtained with a Test Class I SPD with I_{imp} of at least 5 kA and I_n of at least 15 kA. More attention is deserved to the choice of the protection level U_p : if the SPDs are installed less than 10 meters far from the devices to be protected, only the length of the connections shall be taken into account, according to the relation [4.8]:

$$U_p = U_{p/f} - \Delta U \leq 0.8 \times U_w - \Delta U \quad [4.8]$$

where $U_{p/f}$ is the actual protection level of the SPD, U_p is the protection level of the SPD, U_w is the impulse withstand voltage of the apparatus to be protected and $\Delta U = \Delta l \times 1 \text{ kV/m}$ is the voltage drop in the connection conductors of the SPD; yet, if the SPDs are of spinterometric type, the $U_{p/f}$ value is the highest of the U_p and ΔU values.

If, on the contrary, the apparatus are more distant, two choices are possible: an additional coordinated Class II SPD close to the apparatus to be protected or the above mentioned Class I SPD with a protection level definitely lower, according to the relation [4.9]:

$$U_p = U_{p/f} - \Delta U \leq 0.5 \times U_w - \Delta U \quad [4.9]$$

Then, it is necessary to provide for the protection of the DC cable arriving to the modules; the first thing to do is a bonding connection between the structure supporting the PV modules and the bonding bar located near the inverter; this connection shall be positioned as close as possible to the DC cable to limit the length of the loop.

The Std. IEC 62305-4 describes how to calculate the voltage induced into such loop and then to have the SPDs sized in case the withstand level is exceeded. Such calculations can be skipped by installing Class II SPDs close to the modules on one side and the inverter on the other.

These Class II SPDs shall have I_n of at least 5 kA, whereas the protection level shall be fixed as already done for the LV line, taking into consideration withstand of the devices and distances.

Figure 4.3

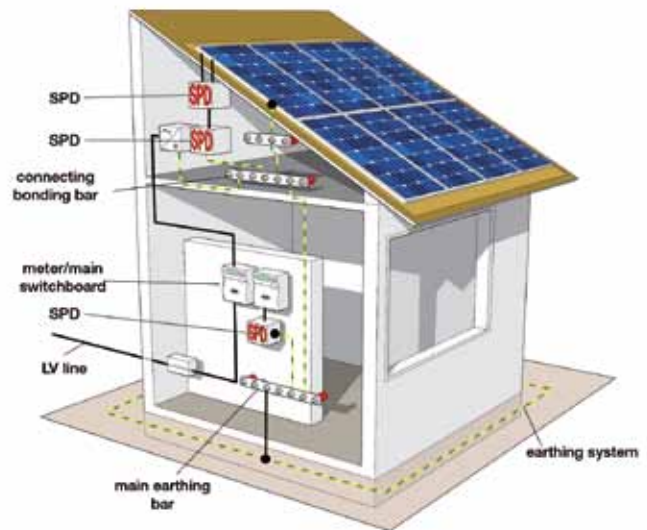

If the installation of an LPS is required, then it is in all cases necessary to provide the protection of the incoming electric line with a Test Class I SPD. SPD's I_{imp} , I_n , U_p and evaluation of the need of additional SPD Class II have to be selected in the same way as described previously. For the DC cables protection, two possibilities are then to be considered:

- a) when separation distance "s" between LPS and PV module is kept:

Figure 4.4

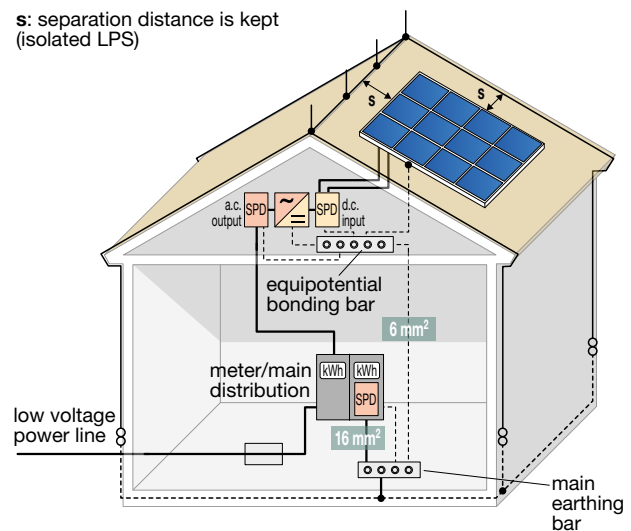

¹¹ Lightning Protection System: it consists of the protective systems, both external (detectors, lightning conductors and ground electrodes) as well as internal (protective measures to reduce the electromagnetic effects of the lightning currents entering the structure to be protected).

Class II SPDs, with I_n of at least 5 kA, shall be installed close to the modules on one side and to the inverter on the other.
 b) when separation distance “s” between LPS and PV module is not kept:

Figure 4.5

< s : separation distance is not kept (non-isolated LPS)

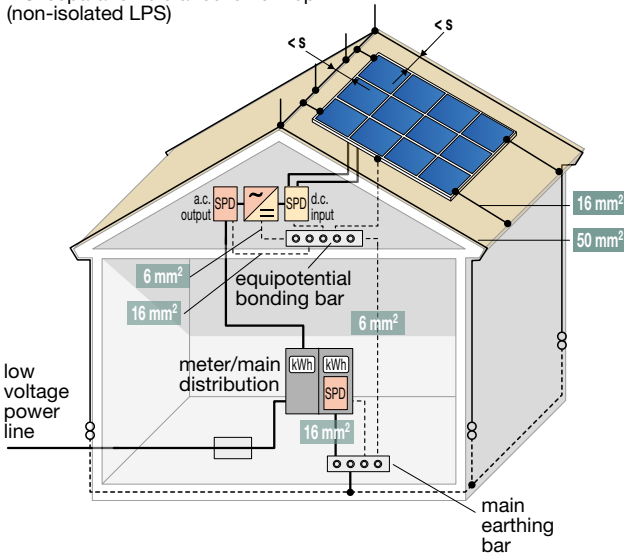

An equipotential bonding of panels’ structure with the LPS is necessary as shown in Figure 4.5. Additionally an SPD Class I is also necessary for the protection of the module and the DC side of the inverter. Current I_{imp} is to be calculated, as described in the Standards, by splitting the lightning current. In both cases, with or without separation distance “s” kept, the required protection level (U_p) of the SPD does not change.

4.4.2. PV plants on ground

The plants installed on ground are generally quite large and are located in rural and remote areas.

Figure 4.6

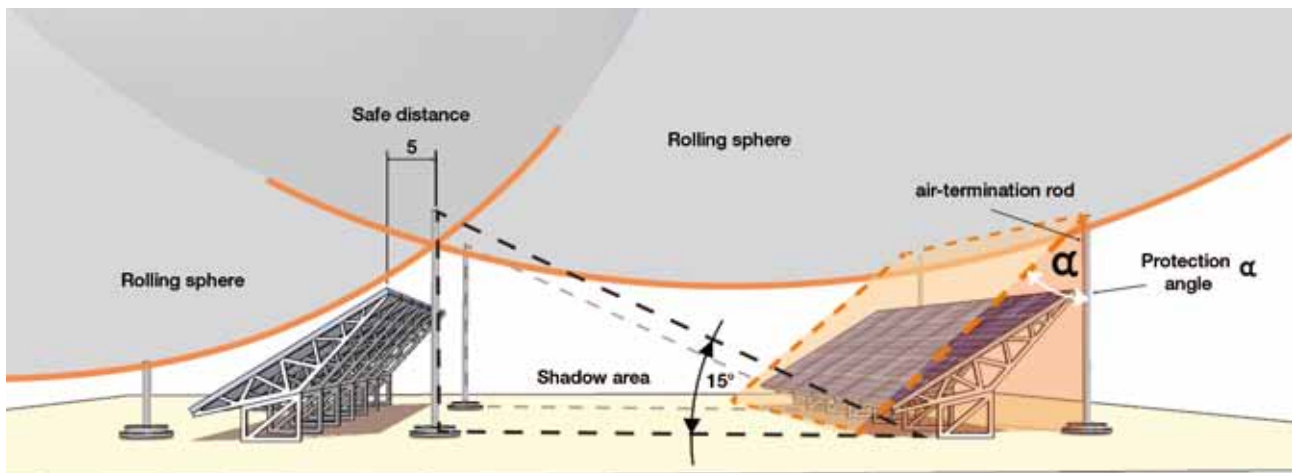

They are typically supplied by a MV three-phase line, which is unshielded and may be many kilometers long. Such line arrives at a MV/LV transformer, on the load side of which there are the inverters, whose withstand voltage is generally equal to 4 kV; the PE conductor, instead, is usually distributed in the same cable of the phase conductors.

Attention shall be paid since a telecom line often enters the PV plant, for the control and monitoring of the plant itself.

First of all, analogously to what is done for the buildings, the collection area is analyzed to determine whether the structure is exposed.

Also when the structure is not exposed, the DC lines must be protected following the same criteria considered for the structures on the roof.

Instead, if the structure is exposed, a lightning protection system (LPS) must be provided.

An LPS class IV or III (LPL III-IV, that is lightning current equal to 100 kA, 10/350) is sufficient. An LPS can be insulated from the PV plant.

Figure 4.7

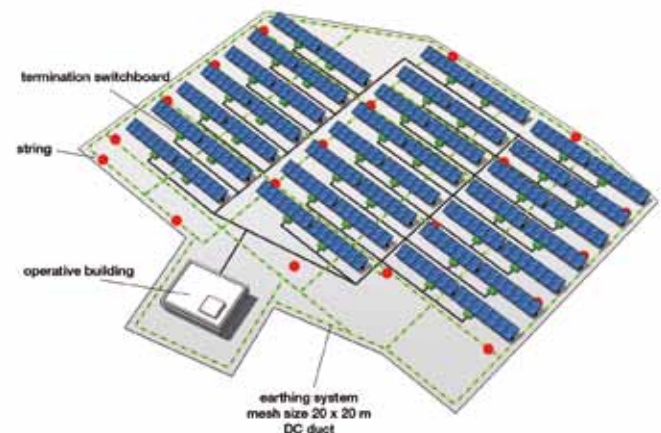

The installation requirements for an external LPS are reported in the Std. IEC 62305-3. The LV power line in alternating current must be protected by means of SPDs, Class I tested, with I_{imp} at least 10 kA and I_n at least 15 kA; as regards U_p the same criterion as in the previous cases can be applied.

The figures below show the structure of a PV plant divided into different zones, from A to D, and indicate the protection functions carried out by an SPD installed in each zone.

Figure 4.8

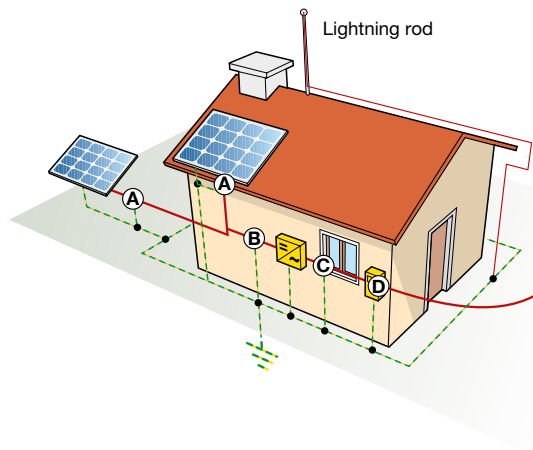
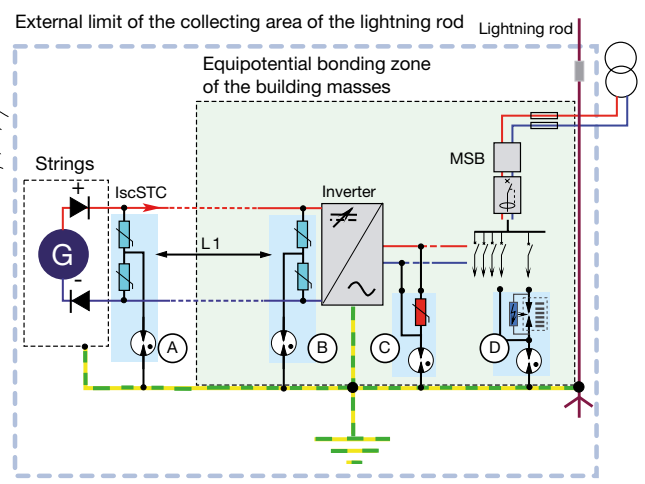
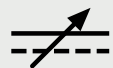





Figure 4.9



Zone	Description	Protection function	When and how
A 	PV array combiner box	Protection of the modules and of the strings against the overvoltages of atmospheric origin.	Recommended if the distance between A and B exceeds 10 m.
B 	Inverter on the DC side	Protection of the inverter against the overvoltages of atmospheric origin.	Always recommended.
C 	Inverter on the AC side	Protection of the inverter against the overvoltages of atmospheric origin.	Recommended if the distance between C and D exceeds 10 m, or if D has a protection level definitely lower according to the relation [4.9].
D 	Beginning of the AC side	Protection of the inverter against the overvoltages of atmospheric origin and originating from the grid.	Always recommended.

5 Earthing and protection against indirect contact

5.1 Earthing

The concept of earthing applied to a photovoltaic (PV) system may involve both the exposed conductive parts (e.g. metal frame of the panels) as well as the generation power system (live parts of the PV system e.g. the cells). A PV system can be earthed only if it is galvanically separated (e.g. by means of a transformer) from the electrical network by means of a transformer.

A PV insulated system could seem apparently safer for the people touching a live part; as a matter of fact, the insulation resistance to earth of the live parts is not infinite and then a person may be passed through by a current returning through such resistance.

Such current rises as the voltage to earth of the plant and the plant size increase, because the insulation resistance to earth decreases.

Besides, the physiological decay of the insulators, due to the passage of time and the presence of humidity, reduces the insulation resistance itself.

Consequently, in very large plants, the current flowing through a person touching the live part may cause electrocution and thus the advantage of insulated systems over earthed systems exists only in case of small plants.

5.2 Plants with transformer

In the plants including a transformer, in addition to the analysis of the PV system either insulated or earthed, for the protection against indirect contact it is necessary to make a difference between the exposed conductive parts upstream or downstream the transformer¹.

5.2.1 Exposed conductive parts on the supply side of the transformer

5.2.1.1 Plant with IT system

In this type of plant the live parts result insulated from earth, whereas the exposed conductive parts are earthed² (Figure 5.1).

Figure 5.1

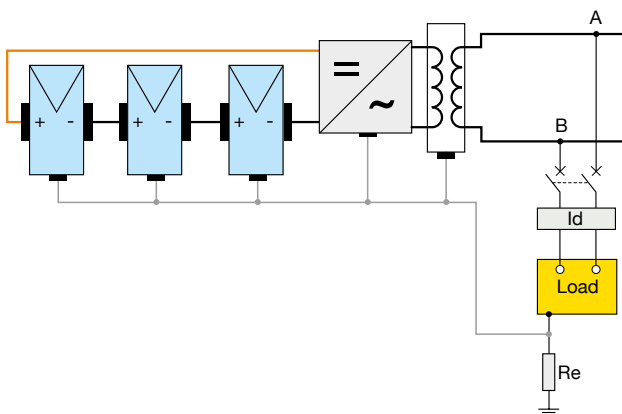

In this case the earthing resistance R_e of the exposed conductive parts shall meet the condition (IEC 60364):

$$R_e \leq \frac{120}{I_d} \quad [5.1]$$

where I_d is the current of first fault to earth, which is not known in advance, but which is generally very low in small-sized plants. As a consequence, the earthing resistance R_e of the consumer plant, which is defined for a fault in the network, usually satisfies only the relation [5.1]. In case of a double earth fault, since the PV generator is a current generator, the voltage of the interconnected exposed conductive parts shall be lower than:

$$I_{sc} \cdot R_{eqp} \leq 120V \quad [5.2]$$

where I_{sc} is the short-circuit current of the cells involved, whereas R_{eqp} is the resistance of the conductor interconnecting the exposed conductive parts affected by fault. For instance, if $R_{eqp} = 1\Omega$ (value approximated by excess), the relation [5.2] is fulfilled for I_{sc} not exceeding 120A, which is usual in small-sized plants; therefore, the effective touch voltage in case of a second earth fault does not result hazardous. On the contrary, in large-sized plants it is necessary to reduce to acceptable limits the chance that a second earth fault occurs, by eliminating the first earth fault detected by the insulation controller (either inside the inverter or external)

5.2.1.2 Plant with TN system

In this type of plant the live parts and the exposed conductive parts are connected to the same earthing system (earthing system of the consumer's plant). Thus, a TN system on the DC side is obtained (Figure 5.2).

Figure 5.2

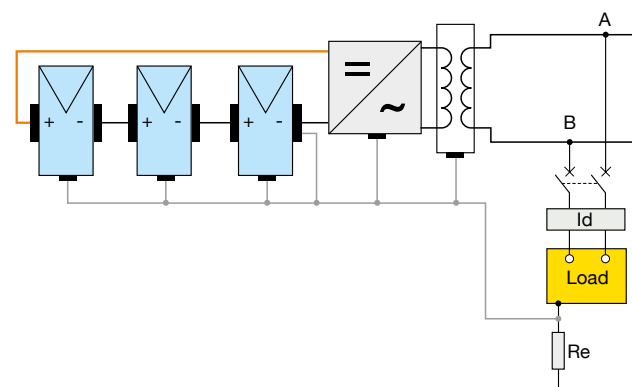

¹In this case upstream and downstream are referred to the direction of the electric power produced by the PV plant.

²For safety reasons the earthing system of the PV plant results to be in common with the consumer's one. However, to make the insulation controller of the inverter operate properly and monitor the PV generator, it is necessary that the frames and/or the supporting structures of the modules (even if of class II) are earthed.

In the presence of an earth fault, a short-circuit occurs as in the usual TN systems, but such current cannot be detected by the maximum current devices since the characteristic of the PV plants is the generation of fault currents with values not much higher than the rated current. Therefore, as regards the hazardousness of this fault, the considerations made in the previous paragraph³ about the second fault in an IT system are valid.

5.2.2 Exposed conductive parts on the load side of the transformer

Take into consideration the network-consumer system of TT type. The exposed conductive parts belonging to the consumer's plant protected by a residual current circuit-breaker positioned at the beginning of the consumer's plant (Figure 5.3), result protected against the faults supplied by both the network as well as by the PV generator.

Figure 5.3

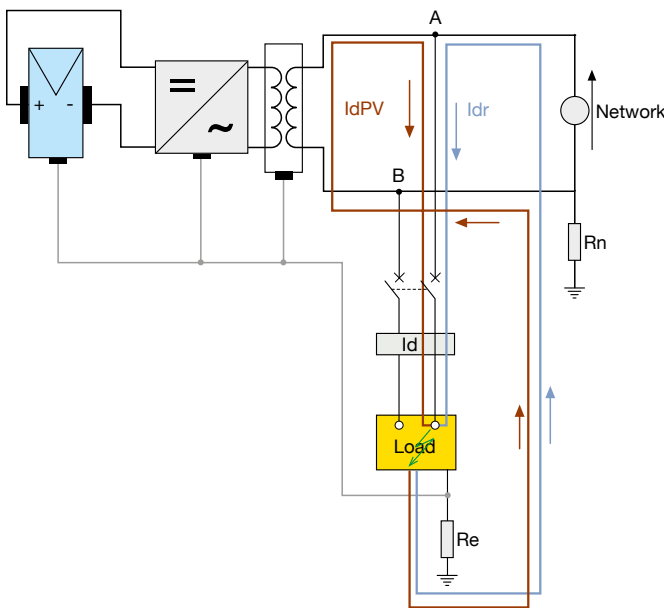

There must not be an exposed conductive part between the parallel point A-B and the network because, in such case, the normative requirement that all the exposed conductive parts of a consumer's plant in a TT system must be protected by a residual current circuit-breaker fails. As regards the exposed conductive parts upstream the parallel point A-B, such as for instance the exposed conductive part of the transformer or of the inverter when

³ The Std. IEC 60364-7 recommends that the whole installation on the DC side (switchboards, cables, and terminal boards included) is erected by use of class II devices or equivalent insulation. However, to make the insulation controller of the inverter operates properly and monitors the PV generator, it is necessary that the frames and/or the supporting structures of the modules (even if class II) are earthed.

⁴ The rated residual current shall be coordinated with the earth resistance R_e , in compliance with the usual relation of TT systems:

$$R_e \leq \frac{50}{I_{dn}}$$

the transformer is incorporated, a residual current device shall be interposed as Figure 5.4 shows; this residual current device⁴ detects the leakage currents coming both from the network as well as from the PV generator. When the residual current device trips due to an earth fault current, the inverter goes in stand by due to lack of network voltage.

Figure 5.4

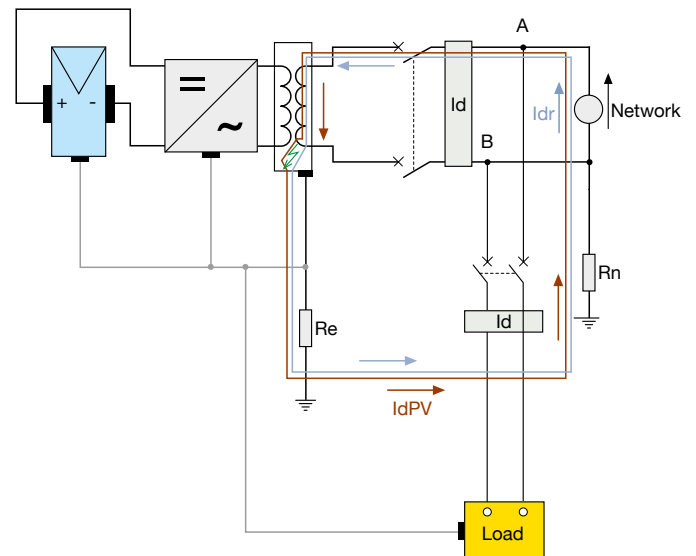

On the contrary, if the network-consumer system is type TN, for both the supply possibilities, either from the network or from the PV generator, residual current circuit-breakers are not needed provided that the fault current on the AC side causes the tripping of the over-current devices by the times prescribed in the Standard. (Figure 5.5).

Figure 5.5

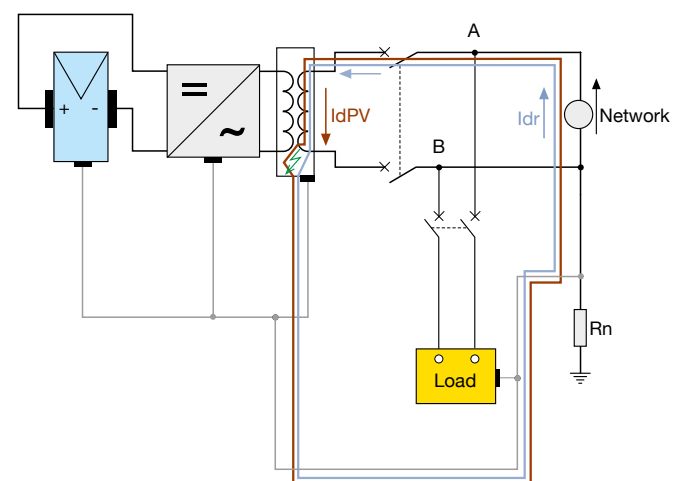

5.3 Plants without transformer

In case of absence of the separation transformer between the PV installation and the network, the PV installation itself shall be insulated from earth in its active parts and becomes an extension of the supply network, generally with a point connected to earth (TT or TN system).

As regards the exposed conductive parts of the consumer's plant and upstream the parallel point A-B, from a conceptual point of view, what described in clause 5.2.2 is still valid.

On the DC side, an earth fault on the exposed conductive parts determines the tripping of the residual current circuit-breaker positioned downstream the inverter (Figure 5.6). After the tripping of the residual current device, the inverter goes in stand by due to the lack of network voltage, but the fault is supplied by the PV generator.

Since the PV system is type IT, the considerations made in clause 5.2.1.1 are valid.

For earth faults on the DC side and on the exposed conductive parts upstream the parallel point A-B, the residual current circuit-breaker on the load side of the inverter is passed through by a residual current which is not alternating. Therefore, such device must be of type B, unless the inverter is by construction such as not to inject DC earth fault currents (IEC 60364-7)⁵.

⁵ The residual current device of type B detects the following typologies of earth fault currents

- alternating (also at frequency exceeding the network one, e.g. up to 1000 Hz)
- pulsating unidirectional
- direct.

⁶ The Std. EN 62040-1 prescribes that the protection of the UPS (which include an inverter) against earth faults is realized by using residual current devices type B (for three-phase UPS) and type A (for single-phase UPS), whenever an earth fault current with DC components may be possible according to the UPS design.

Figure 5.6

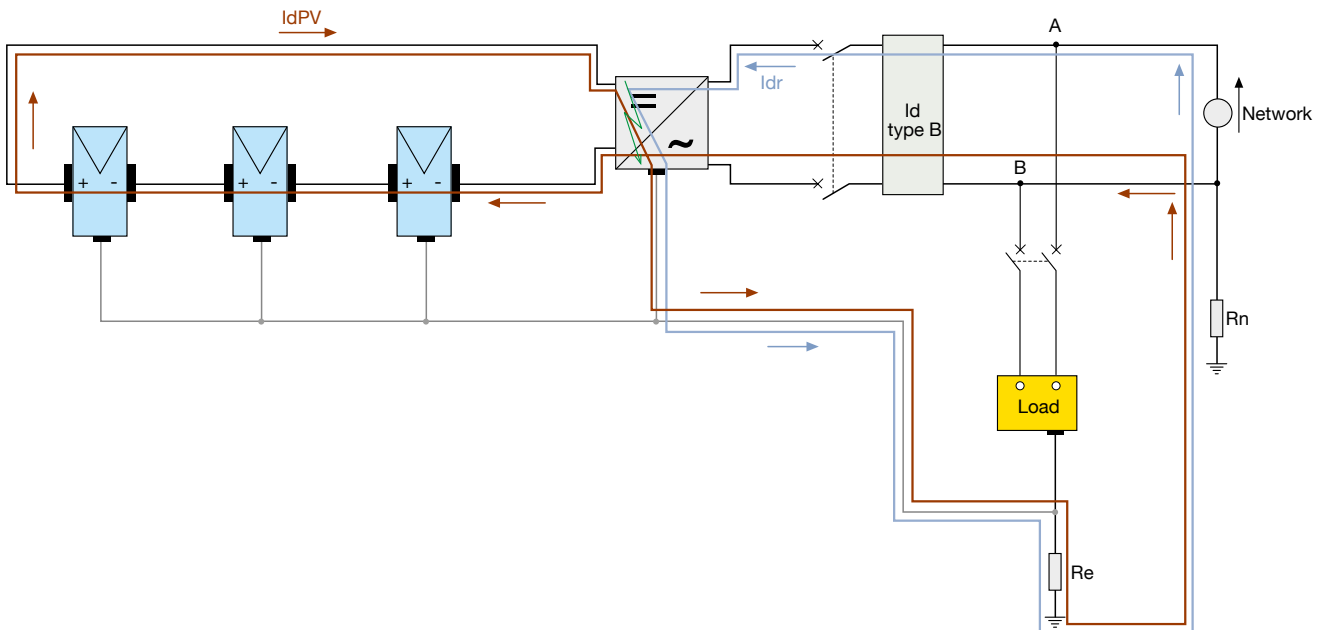

6 ABB solutions for photovoltaic applications

6 ABB solutions for photovoltaic applications

6.1 Molded-case and air circuit-breakers

ABB offers the following types of molded-case and air circuit-breakers and switch-disconnectors for the protection against overcurrents and the disconnection of PV installations both in the DC as well in the AC section.

6.1.1 New series of molded-case circuit-breakers SACE Tmax XT

ABB offers also the new series of molded-case circuit-breakers SACE Tmax XT up to 250A.

For the protection of the AC section of PV installations the following circuit-breakers are available:

- XT1 160 and XT3 250, equipped with thermomagnetic trip units type TMD with adjustable thermal threshold ($I_1 = 0.7..1 \times I_n$) and fixed magnetic threshold ($I_3 = 10 \times I_n$);
- XT2 160 and XT4 250, equipped with thermomagnetic trip units type TMA (for $I_n \geq 40A$) with adjustable thermal threshold ($I_1 = 0.7..1 \times I_n$) and adjustable magnetic threshold I_3 adjustable in the range $8..10 \times I_n$ for 40A, $6..10 \times I_n$ for 50A and $5..10 \times I_n$ for $I_n \geq 63A$, or equipped with Ekip electronic trip units also with neutral increased at 160%.

		XT1					XT2					XT3		XT4				
Size	[A]	160					160					250		160/250				
Poles	[Nr.]	3/4					3/4					3/4		3/4				
Rated service voltage, U_e	[V (AC) 50-60 Hz]	690					690					690		690				
Rated impulse withstand voltage, U_{imp}	[kV]	8					8					8		8				
Rated insulation voltage, U_i	[V]	800					1000					800		1000				
Rated ultimate short-circuit breaking capacity, I_{cu}		B	C	N	S	H	N	S	H	L	V	N	S	N	S	H	L	V
(AC) 240V 50-60Hz	[kA]	25	40	65	85	100	65	85	100	150	200	50	85	65	85	100	150	200
(AC) 380V 50-60Hz	[kA]	18	25	36	50	70	36	50	70	120	200	36	50	36	50	70	120	150
(AC) 415V 50-60Hz	[kA]	18	25	36	50	70	36	50	70	120	150	36	50	36	50	70	120	150
(AC) 440V 50-60Hz	[kA]	15	25	36	50	65	36	50	65	100	150	25	40	36	50	65	100	150
(AC) 500V 50-60Hz	[kA]	8	18	30	36	50	30	36	50	60	70	20	30	30	36	50	60	70
(AC) 525V 50-60Hz	[kA]	6	8	22	35	35	20	25	30	36	50	13	20	20	25	45	50	50
(AC) 690V 50-60Hz	[kA]	3	4	6	8	10	10	12	15	18	20	5	8	10	12	15	20	25 (90) ⁽¹⁾
Utilization Category (IEC 60947-2)		A					A					A		A				
Isolation behaviour		■					■					■		■				
Trip units: thermomagnetic																		
T regolabile, M fixed	TMD	■					■ (up to 32A)					■		■ (up to 32A)				
T adjustable, M adjustable	TMA	-					■					-		■				
magnetic only	MF/MA	-					■					■		■				
electronic Ekip		-					■					-		■				
Interchangeable		-					■					-		■				
Versions		F-P					F-P-W					F-P		F-P-W				

⁽¹⁾ 90 kA @ 690 V for XT4 160A only. Available in a short time, ask ABB SACE.



6.1.2 Tmax T molded-case circuit-breakers for alternating current applications

Tmax molded-case circuit-breakers complying with the Std. IEC 60947-2 have 690V rated operational voltage and breaking capacities up to 200kA (at 380/415V AC). For the protection of the AC section in PV installations the following circuit-breakers are available:

- Tmax T5 and T6, equipped with thermomagnetic trip units type TMA with adjustable thermal ($I_1 = 0.7..1 \times I_n$) and magnetic ($I_3 = 5..10 \times I_n$) thresholds;
- Tmax T4, T5 and T6 with electronic trip units type PR221DS, PR222DS and PR223DS;
- Tmax T7, equipped with electronic trip units type PR231/P, PR232/P, PR331/P and PR332/P, available in two versions: with manual or motorizable stored energy operating mechanism.

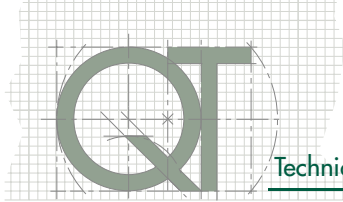

	T4					T5					T6				T7			
Rated uninterrupted current I_u [A]	320					400/630					630/800/1000				800/1000 1250/1600			
Poles [Nr.]	3/4					3/4					3/4				3/4			
Rated service voltage U_e [V (AC) 50-60 Hz]	690					690					690				690			
Rated impulse withstand voltage U_{imp} [kV]	8					8					8				8			
Rated insulation voltage U_i [V]	1000					1000					1000				1000			
Test voltage at industrial frequency for 1 min. [V]	3500					3500					3500				3500			
Rated ultimate short-circuit breaking capacity I_{cu}	N	S	H	L	V	N	S	H	L	V	N	S	H	L	S	H	L	V ⁽³⁾
(AC) 220-230V 50-60Hz [kA]	70	85	100	200	200	70	85	100	200	200	70	85	100	200	85	100	200	200
(AC) 380-400-415V 50-60Hz [kA]	36	50	70	120	200	36	50	70	120	200	36	50	70	100	50	70	120	150
(AC) 440V 50-60Hz [kA]	30	40	65	100	180	30	40	65	100	180	30	45	50	80	50	65	100	130
(AC) 500V 50-60Hz [kA]	25	30	50	85	150	25	30	50	85	150	25	35	50	65	50	50	85	100
(AC) 690V 50-60Hz [kA]	20	25	40	70	80	20	25	40	70	80	20	22	25	30	30	42	50	60
Utilization category (IEC 60947-2)	A					B (400A) ⁽¹⁾ - A (630A)					B (630A-800A) ⁽²⁾ A (1000A)				B ⁽⁴⁾			
Isolation behaviour	■					■					■				■			
Trip units:																		
thermomagnetic	T adjustable, M adjustable (5...10 x I _n) TMA					■ (up to 500A)					■ (up to 800A)				-			
electronic	PR221DS					■					■				-			
	PR222DS					■					■				-			
	PR223DS					■					■				-			
	PR231/P					-					-				■			
	PR232/P					-					-				■			
	PR331/P					-					-				■			
	PR332/P					-					-				■			
Interchangeability	■					■					■				■			
Versions	F-P-W					F-P-W					F-W				F-W			

⁽¹⁾ I_{cw} = 5kA

⁽²⁾ I_{cw} = 7.6kA (630A) - 10kA (800A)

⁽³⁾ For T7 800/1000/1250A only

⁽⁴⁾ I_{cw} = 20kA (S,H,L version) - 15kA (V version)

6.1.3 Molded-case circuit-breakers for applications up to 1150V AC

The panorama of Tmax T solutions includes also the automatic circuit-breakers T4, T5 and T6 for alternating current applications up to 1150V. These circuit-breakers are available in the three-pole and four-pole version with TMD or TMA thermomagnetic trip units, or with electronic

trip units type PR221DS, PR222DS and PR223DS.

These circuit-breakers are available in fixed, plug-in and withdrawable versions (for them the use of the 1000V fixed parts, which can be supplied by upper terminals only, is required) and comply with all accessories except for the residual current release.

T4-T5 circuit-breakers for use up to 1150 V AC and T6 circuit-breakers for use up to 1000 V AC

		T4		T5		T6
Rated uninterrupted current, I_u	[A]	250		400/630		630/800
Poles		3/4		3/4		3/4
Rated service voltage, U_e	[V]	1000	1150	1000	1150	1000
Rated impulse withstand voltage, U_{imp}	[kV]	8		8		8
Rated insulation voltage, U_i	[V]	1000	1150	1000	1150	1000
Test voltage at industrial frequency for 1 min.	[V]	3500		3500		3500
Rated ultimate short-circuit breaking capacity, I_{cu}		L	V ⁽¹⁾	L	V ⁽¹⁾	L ⁽¹⁾
(AC) 1000V 50-60Hz	[kA]	12	20	12	20	12
(AC) 1150V 50-60Hz	[kA]	-	12	-	12	-
Utilization category (IEC 60947-2)		A		B (400A) ⁽²⁾ - A (630A)		B ⁽³⁾
Isolation behaviour		■		■		■
Trip units: thermomagnetic						
T adjustable, M fixed	TMD		■			
T adjustable, M adjustable (5...10 x I _n)	TMA		■		■	■
electronic						
PR221DS		■	■	■	■	■
PR222DS		■	■	■	■	■
Versions		F-P-W	F	F-P-W ⁽⁴⁾	F	F ⁽⁵⁾

⁽¹⁾ Supply from the top only

⁽²⁾ I_{cw} = 5kA

⁽³⁾ I_{cw} = 7.6kA (630A) - 10kA (800A)

⁽⁴⁾ Tmax T5 630 is available in the fixed version only

⁽⁵⁾ For T6 in the withdrawable version ask ABB

Rated currents available for Tmax T molded-case circuit-breakers with electronic type trip units

	I _n [A]	320	400	630	800	1000	1250	1600
	T4	■						
	T5	■	■	■				
	T6			■	■	■		
PR222DS/P	T4	■						
PR222DS/PD	T5	■	■	■				
PR223DS	T6			■	■	■		
PR231/P PR232/P PR331/P PR332/P	T7		■	■	■	■	■	■

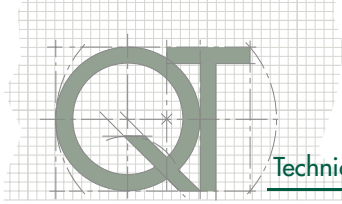

Rated currents available for Tmax T molded-case circuit-breakers with thermomagnetic type trip units

In [A]	T5 400-630	T6 630-800
	TMA	TMA
320	■	
400	■	
500	■	
630		■
800		■

TMA = thermomagnetic trip unit with adjustable thermal and magnetic thresholds

Rated currents available for SACE Tmax XT molded-case circuit-breakers with Ekip electronic trip unit

Ekip	In [A]	10	25	40	63	100	160	250
	XT2		■	■		■	■	■
XT4				■	■	■	■	■

Rated currents available for SACE Tmax XT molded-case circuit-breakers with magnetic type trip units

In [A]	XT1 160	XT2 160			XT3 250		XT4 160-250	
	TMD	TMD/TMA	MF	MA	TMD	MA	TMD/TMA	MA
1			■					
1,6		■						
2		■	■					
2,5		■						
3,2		■						
4		■	■					
5		■						
6,3		■						
8		■						
8,5			■					
10		■						■
12,5		■	■					■
16	■	■					■	
20	■	■		■			■	■
25	■	■					■	■
32	■	■		■			■	■
40	■	■					■	
50	■	■					■	
52				■				■
63	■	■			■		■	
80	■	■		■	■		■	■
100	■	■		■	■	■	■	■
125	■	■			■	■	■	■
160	■	■			■	■	■	■
200					■	■	■	■
225								
250					■		■	

MF = magnetic only trip unit with fixed threshold
 MA = magnetic only trip unit with adjustable threshold
 TMD = thermomagnetic trip unit with adjustable thermal and fixed magnetic thresholds
 TMA = thermomagnetic trip unit with adjustable thermal and magnetic thresholds

6.1.4 Molded-case switch-disconnectors Tmax T and SACE Tmax XT

Tmax T and SACE Tmax XT switch-disconnectors derive from the corresponding automatic circuit-breakers from which they differ only for the absence of the protection trip units.

The main function carried out by these devices is the disconnection of the circuit in which they are installed. In fact, once the contacts are open, they are at such a distance that the arc is prevented from striking, in compliance with the prescriptions of the Standards as regards

the isolation behavior.

The position of the operating lever corresponds definitely with that of the contacts (positive operation). Each switch-disconnector must be protected on the supply side by a coordinated device which safeguards it against short-circuits.

The Tmax and SACE Tmax XT automatic circuit-breaker which can carry out this protection function is always a device of a size corresponding to or smaller than the switch-disconnector in question.

		T4D	T5D	T6D	T7D
Conventional thermal current, I_{th}	[A]	320	400/630	630/800/1000 ⁽¹⁾	1000/1250/1600
Rated service current in category AC22, I_e	[A]	320	400/630	630/800/1000	1000/1250/1600
Rated service current in category AC23, I_e	[A]	250	400	630/800/800	1000/1250/1250
Poles	[Nr.]	3/4	3/4	3/4	3/4
Rated service voltage, U_e	[V] (AC) 50-60 Hz	690	690	690	690
Rated impulse withstand voltage, U_{imp}	[kV]	8	8	8	8
Rated insulation voltage, U_i	[V]	800	800	1000	1000
Test voltage at industrial frequency for 1 minute	[V]	3500	3500	3500	3500
Rated short-time withstand current for 1s, I_{cw}	[kA]	3,6	6	15	20
Reference Standard		IEC 60947-3	IEC 60947-3	IEC 60947-3	IEC 60947-3
Versions		F-P-W	F-P-W	F-W	F-W

⁽¹⁾ Withdrawable version not available for T6 1000 A

		XT1D	XT3D	XT4D
Conventional thermal current, I_{th}	[A]	160	250	250
Rated service current in category AC22, I_e	[A]	160	250	250
Rated service current in category AC23, I_e	[A]	125	200	200
Poles	[Nr.]	3/4	3/4	3/4
Rated service voltage, U_e	[V] (AC) 50-60 Hz	690	690	690
Rated impulse withstand voltage, U_{imp}	[kV]	8	8	8
Rated insulation voltage, U_i	[V]	800	800	800
Test voltage at industrial frequency for 1 minute	[V]	3000	3000	3000
Rated short-time withstand current for 1s, I_{cw}	[kA]	2	3,6	3,6
Reference Standard		IEC 60947-3	IEC 60947-3	IEC 60947-3
Versions		F-P	F-P	F-P-W



6.1.5 Air circuit-breakers for alternating current applications

The air circuit-breakers series Emax E1..E6, complying with the Std. IEC 60947-2, have an application range from 400A to 6300A, breaking capacities from 42kA to 150kA @ 400V and are equipped with electronic trip units type PR121/P, PR122/P and PR123/P.

Emax X1 automatic circuit-breakers have application filed ranging from 400A to 1600A, breaking capacities from 42KA to 150kA @ 400V and are equipped with electronic trip units type PR331/P, PR332/P and PR333/P.

		E1			E2			E3			E4			E6			X1				
Rated service voltage, Ue	[V]	690			690			690			690			690			690				
Rated impulse withstand voltage, Uimp	[kV]	12			12			12			12			12			12				
Rated insulation voltage, Ui	[V]	1000			1000			1000			1000			1000			1000				
Poles	[Nr.]	3/4			3/4			3/4			3/4			3/4			3/4				
Rated uninterrupted current Iu		B	N	B	N	S	L	N	S	H	V	L	S	H	V	H	V	B	N	L	
	[A]	800	800	1600	1000	800	1250	2500	1000	800	800	2000	4000	3200	3200	4000	3200	630	630	630	
	[A]	1000	1000	2000	1250	1000	1600	3200	1250	1000	1250	2500		4000	4000	5000	4000	800	800	800	
	[A]	1250	1250		1600	1250			1600	1250	1600						6300	5000	1000	1000	1000
	[A]	1600	1600		2000	1600			2000	1600	2000							6300	1250	1250	1250
	[A]					2000			2500	2000	2500								1600	1600	
	[A]								3200	2500	3200										
[A]									3200												
Rated ultimate breaking capacity under short-circuit Icu																					
220-230-380-400-415V 50-60Hz	[kA]	42	50	42	65	85	130	65	75	100	130	130	75	100	150	100	150	42	65	150	
440V 50-60Hz	[kA]	42	50	42	65	85	110	65	75	100	130	110	75	100	150	100	150	42	65	130	
500V 50-60Hz	[kA]	42	50	42	55	65	85	65	75	100	100	85	75	100	130	100	130	42	55	100	
690V 50-60Hz	[kA]	42	50	42	55	65	85	65	75	85(*)	100	85	75	85(*)	100	100	100	42	55	60	
Rated short-time withstand current for 1s, Icw	[kA]	42	50	42	55	65	10	65	75	75	85	15	75	100	100	100	100	42	42	15	
Utilization category (IEC 60947-2)		B	B	B	B	B	A	B	B	B	B	A	B	B	B	B	B	B	B	A	
Isolation behaviour		■		■				■					■			■		■		■	
Versions		F-W		F-W				F-W					F-W			F-W		F-W		F-W	

(*) The performance at 600V is 100kA

6.1.6 New automatic circuit-breakers for alternating current

ABB offers the new series of air circuit-breakers SACE Emax 2 up to 6300A. Able to control the electric plant effectively, in a simple way and with a minimum energy impact, the new SACE Emax 2 represent the evolution of the circuit-breaker into a Power Manager. The range consists of 4 sizes: E1.2, E2.2, E4.2, E6.2, allowing compact-dimensioned, high-performing switchboards to be realized, with busbars of reduced length and cross-section.

Protection trip units, auxiliary connections and main accessories are common to the whole series, to simplify design and installation. Moreover, the sizes from E2.2 to E6.2 have the same height and depth.

In particular:

- E1.2 ensures 1600A with I_{cu} up to 66kA and I_{cw} of 50kA for 1s, in an extremely compact architecture. It offers the sturdiness of SACE Emax with reduced dimensions and allows 66kA switchboards on 400mm columns to be realized, in three- and four-pole version, which is essential where a reduction of the overall dimensions is fundamental, typically in marine and offshore installations;
- E2.2 allows carrying capacities up to 2500A to be obtained in switchboards with 400mm width for three-pole versions, with I_{cu} up to 100kA and I_{cw} up to 85kA for 1s;
- E4.2 is the new 4000A circuit-breaker, designed to carry high current values and I_{cw} of 100kA without taking special measures;
- E6.2 is the top of the series with I_{cu} up to 200kA and an architecture ensuring to reach 6300A in switchboard, also under complex installation conditions.

Common data		
Rated service voltage U_e	[V]	690
Rated insulation voltage U_i	[V]	1000
Rated impulse withstand voltage U_{imp}	[kV]	12
Frequency	[Hz]	50 - 60
Number of poles		3 - 4
Version		Fixed - Withdrawable
Isolation behaviour		IEC 60947-2



SACE Emax 2		E1.2				E2.2				E4.2				E6.2			
		B	C	N	L	B	N	S	H	N	S	H	V	H	V	X	
Performance levels																	
Rated uninterrupted current I_u @ 40°C	[A]	630	630	250	630	1600	800	250	800	3200	3200	3200	2000	4000	4000	4000	
	[A]	800	800	630	800	2000	1000	800	1000	4000	4000	4000	2500	5000	5000	5000	
	[A]	1000	1000	800	1000	1250	1000	1250					3200	6300	6300	6300	
	[A]	1250	1250	1000	1250	1600	1250	1600					4000				
	[A]	1600	1600	1250		2000	1600	2000									
	[A]			1600		2500	2000	2500									
	[A]							2500									
Neutral pole current-carrying capacity for 4-pole CBs	[% I_u]	100	100	100	100	100	100	100	100	100	100	100	100	50-100	50-100	50-100	
Rated ultimate short-circuit breaking capacity I_{cu}	400-415V	[kA]	42	50	66	150	42	66	85	100	66	85	100	150	100	150	200
	440V	[kA]	42	50	66	130	42	66	85	100	66	85	100	150	100	150	200
	500-525V	[kA]	42	42	50	100	42	66	66	85	66	66	85	100	100	130	130
	690V	[kA]	42	42	50	60	42	66	66	85	66	66	85	100	100	100	120
Rated service short-circuit breaking capacity I_{cs}	[% I_{cu}]	100	100	100 ¹⁾	100	100	100	100	100	100	100	100	85	100	100	100	
Rated short-time withstand current I_{sw}	(1s)	[kA]	42	42	50	15	42	66	66	85	66	66	85	100	100	100	120
	(3s)	[kA]	24	24	36		42	50	50	66	36	50	66	75	100	100	100
Rated short-circuit making capacity (peak value) I_{cm}	400-415V	[kA]	88	105	145	330	88	145	187	220	145	187	220	330	220	330	440
	440V	[kA]	88	105	145	286	88	145	187	220	145	187	220	330	220	330	440
	500-525V	[kA]	88	88	105	220	88	145	145	187	145	145	187	220	220	286	286
	690V	[kA]	88	88	105	132	88	145	145	187	145	145	187	220	220	220	264
Utilization category (according to IEC 60947-2)			B	B	B	A	B	B	B	B	B	B	B	B	B	B	
Breaking	Breaking time for $I < I_{cw}$		40	40	40	40	40	40	40	40	40	40	40	40	40	40	
	Breaking time for $I > I_{cw}$		25	25	25	10	25	25	25	25	25	25	25	25	25	25	

¹⁾ I_{cs} : 50kA for 400V...440V voltage

6.1.7 Air circuit-breakers for applications up to 1150V AC

Emax circuit-breakers can be supplied, in a special version, for rated service voltages up to 1150V in alternating current.

The circuit-breakers in this version are identified by the

letters of the standard range plus “/E” and are derived from the corresponding standard SACE Emax circuit-breakers, of which they maintain the same versions and accessories. They can be either fixed or withdrawable, in both three- and four-pole versions.

		E2B/E	E2N/E	E3H/E	E4H/E	E6H/E	X1B/E	
Rated service voltage, Ue	[V]	1150	1150	1150	1150	1150	1000	
Rated impulse withstand voltage, Uimp	[kV]	12	12	12	12	12	12	
Rated insulation voltage, Ui	[V]	1250	1250	1250	1250	1250	1000	
Poles	[Nr.]	3/4	3/4	3/4	3/4	3/4	3/4	
Rated uninterrupted current Iu	[A]	1600	1250	1250	3200	4000	630	
	[A]	2000	1600	1600	4000	5000	800	
	[A]		2000	2000		6300	1000	
	[A]			2500			1250	
	[A]			3200			1600	
Rated ultimate breaking capacity under short-circuit Icu								
	1000V 50-60Hz	[kA]	20	30	50	65	65	20
	1150V 50-60Hz	[kA]	20	30	30	65	65	-
Rated short-time withstand current for 1s Icw	[kA]	20	30	50(*)	65	65	20	

*) 30 kA @ 1150 V

Rated currents available for air circuit-breakers Emax and Emax X1 with the different types of electronic trip units

	In [A]	400	630	800	1000	1250	1600	2000	2500	3200	4000	5000	6300
PR121/P PR122/P PR123/P	E1	■	■	■	■	■	■						
	E2	■	■	■	■	■	■	■					
	E3	■	■	■	■	■	■	■	■	■	■		
	E4			■	■	■	■	■	■	■	■		
	E6			■	■	■	■	■	■	■	■	■	■
PR331/P PR332/P PR333/P	X1	■	■	■	■	■	■						
		■	■	■	■	■	■						
		■	■	■	■	■	■						

6.1.8 New air circuit-breakers for applications up to 1150V AC

ABB offers a solution designed for applications with voltage values up to 1150V, while keeping the same overall

dimensions and accessories as the standard 690V AC series. This series is identified by the letter “/E”.

Common data		
Rated service voltage Ue	[V]	1150
Rated insulation voltage Ui	[V]	1250
Rated impulse withstand voltage Uimp	[kV]	12
Frequency	[Hz]	50 - 60
Number of poles		3 - 4
Version		Fixed - Withdrawable
Isolation behaviour		IEC 60947-2



SACE Emax 2			E1.2	E2.2	E4.2	E6.2
Performance levels			N/E	H/E	H/E	X/E
Rated uninterrupted current Iu @ 40°C		[A]	630	800	3200	4000
		[A]	800	1000	4000	5000
		[A]	1000	1250		6300
		[A]	1250	1600		
		[A]	1600	2000		
		[A]		2500		
Neutral pole current-carrying capacity for 4-pole CBs	%Iu		100	100	100	50 - 100
Rated ultimate short-circuit breaking capacity Icu	1000V	[kA]	30	30	50	65
	1150V	[kA]	25	30	30	65
Rated service short-circuit breaking capacity Ics			100	100	100	100
Rated short-time withstand current Icw	(1s)	[kA]	25	30	50	65
	(3s)	[kA]	25	30	30	65
Rated short-circuit making capacity (peak value) Icm	1000V	[kA]	63	63	105	143
	1150V	[kA]	53	53	105	143
Utilization category (according to IEC 60947-3)			B	B	B	B

6.1.9 Air switch-disconnectors

The switch-disconnectors are derived from the corresponding standard circuit-breakers, of which they maintain the overall dimensions and the possibility of mounting the same accessories.

They differ from the standard circuit-breakers only in the absence of the electronic overcurrent trip units.

They are available in both fixed and withdrawable, three- and four-pole versions; they are identified by the letters “/MS” and can be used in utilization category AC-23A (switching of motor loads or other highly inductive loads) in compliance with the Std. IEC 60947-3.

		E1B/MS	E1N/MS	E2B/MS	E2N/MS	E2S/MS	E3N/MS	E3S/MS	E3V/MS	E4S/MS	E4H/MS	E6H/MS	X1B/MS
Rated service voltage U_e	[V ~]	690	690	690	690	690	690	690	690	690	690	690	690
	[V -]	250	250	250	250	250	250	250	250	250	250	250	250
Rated impulse withstand voltage U_{imp}	[kV]	12	12	12	12	12	12	12	12	12	12	12	12
Rated insulation voltage U_i	[V ~]	1000	1000	1000	1000	1000	1000	1000	1000	1000	1000	1000	1000
Poles	[Nr.]	3/4	3/4	3/4	3/4	3/4	3/4	3/4	3/4	3/4	3/4	3/4	3/4
Rated uninterrupted current I_u	[A]	800	800	1600	1000	1000	2500	1000	800	4000	3200	4000	1000
	[A]	1000	1000	2000	1250	1250	3200	1250	1250		4000	5000	1250
	[A]	1250	1250		1600	1600		1600	1600			6300	1600
	[A]	1600	1600		2000	2000		2000	2000				
	[A]							2500	2500				
	[A]							3200	3200				
	[A]												
Rated short-time withstand current for 1s I_{cw}	[kA]	42	50	42	55	65	65	75	85	75	100 ⁽¹⁾	100	42

Note: The breaking capacity I_{cu} at the maximum service voltage, when using an external protective relay with 500ms maximum timing, is equal to the value of I_{cw} (1s), except for:

⁽¹⁾ I_{cu} = 85 kA @ 690 V

6.1.10 New air switch-disconnectors

The new switch-disconnectors SACE Emax 2, identified by the letters “/MS”, are devices which satisfy the insulation requirements specified in the Standard IEC 60947-3.

They derive from the corresponding automatic circuit-breakers, of which they maintain the overall dimensions and the possibility of mounting accessories.

This version differs from the automatic circuit-breakers only in the absence of the protection trip units.

The device, when in open position, guarantees such an insulation distance between the main contacts of the circuit-breaker that the plant on the load side results not to be live. Moreover, the switch-disconnector, if used with an external protective trip unit with 500ms maximum delay time, ensures a breaking capacity at the maximum service voltage (U_n) equal to the admissible short-time withstand current value (I_{cw}) for 1s.

Common data		
Rated service voltage U_e	[V]	690
Rated insulation voltage U_i	[V]	1000
Rated impulse withstand voltage U_{imp}	[kV]	12
Frequency	[Hz]	50 - 60
Number of poles		3 - 4
Version		Fixed - Withdrawable
Isolation behaviour		IEC 60947-3



SACE Emax 2			E1.2		E2.2		E4.2		E6.2			
Performance levels			B/MS	N/MS	B/MS	N/MS	H/MS	N/MS	H/MS	V/MS	H/MS	X/MS
Rated uninterrupted current I_u @ 40°C	[A]		630	250	1600	800	800	3200	3200	2000	4000	4000
	[A]		800	630	2000	1000	1000	4000	4000	2500	5000	5000
	[A]		1000	800		1250	1250			3200	6300	6300
	[A]		1250	1000		1600	1600			4000		
	[A]		1600	1250		2000	2000					
	[A]			1600		2500	2500					
Neutral pole current-carrying capacity for 4-pole CBs	[% I_u]		100	100	100	100	100	100	100	100	50-100	50-100
Rated short-time withstand current I_{cw}	(1s)	[kA]	42	50	42	66	85	66	85	100	100	120
	(3s)	[kA]	24	36	42	50	66	36	66	75	100	100
Rated short-circuit making capacity (peak value) I_{cm}	400-415V	[kA]	88	105	88	145	187	145	187	220	220	264
	440 V	[kA]	88	105	88	145	187	145	187	220	220	264
	500-525V	[kA]	88	105	88	145	187	145	187	220	220	264
	690 V	[kA]	88	105	88	145	187	145	187	220	220	264
Utilization category (according to IEC 60947-3)			AC-23A	AC-23A	AC-23A	AC-23A	AC-23A	AC-23A	AC-23A	AC-23A	AC-23A	AC-23A

6.1.11 Air switch-disconnectors for applications up to 1150V AC

Emax switch-disconnectors can be supplied, in special version, for rated service voltages up to 1150V in alternating current.

The circuit-breakers in this version are identified by the

letters of the standard range plus “/E” and are derived from the corresponding standard switch-disconnectors. They are available in the three-pole and four-pole, fixed and withdrawable versions, with the same overall dimensions, accessory options and installations as the corresponding standard circuit-breakers.

		E2B/E MS	E2N/E MS	E3H/E MS	E4H/E MS	E6H/E MS	X1B/E MS
Rated service voltage Ue	[V]	1150	1150	1150	1150	1150	1000
Rated impulse withstand voltage Uimp	[kV]	12	12	12	12	12	12
Rated insulation voltage Ui	[V]	1250	1250	1250	1250	1250	1000
Poles	[Nr.]	3/4	3/4	3/4	3/4	3/4	3/4
Rated uninterrupted current Iu	[A]	1600	1250	1250	3200	4000	1000
	[A]	2000	1600	1600	4000	5000	1250
	[A]		2000	2000		6300	1600
	[A]			2500			
	[A]			3200			
Rated short-time withstand current for 1s Icw	[kA]	20	30	30(*)	65	65	20

Note: The breaking capacity I_{cu} , when using an external protective release with 500ms maximum timing, is equal to the value of I_{cw} (1s)

(*) $I_{cu} = 50 \text{ kA @ } 1000 \text{ V}$.

6.1.12 New air switch-disconnectors for applications up to 1150V AC

The new switch-disconnectors for applications up to 1150V AC, identified by the letters “/E” and “/MS”, derive from the corresponding automatic circuit-breakers, of which they maintain the overall dimensions and the possibility of mounting accessories.

The switch-disconnectors are not equipped with Ekip protective units; by using an external protective trip unit with 500ms maximum time delay, the breaking capacity I_{cu} at the maximum service voltage (U_n) is equal to the I_{cw} value for 1s.

Common data		
Rated service voltage U_e	[V]	1150
Rated insulation voltage U_i	[V]	1250
Rated impulse withstand voltage U_{imp}	[kV]	12
Frequency	[Hz]	50 - 60
Number of poles		3 - 4
Version		Fixed - Withdrawable
Isolation behaviour		IEC 60947-3



SACE Emax 2			E1.2	E2.2	E4.2	E6.2
Performance levels			N/E MS	H/E MS	H/E MS	X/E MS
Rated uninterrupted current I_u @ 40 °C		[A]	630	800	3200	4000
		[A]	800	1000	4000	5000
		[A]	1000	1250		6300
		[A]	1250	1600		
		[A]	1600	2000		
		[A]		2500		
Neutral pole current-carrying capacity for 4-pole CBs	% I_u		100	100	100	50 - 100
Rated short-time withstand current I_{st}	(1s)	[kA]	25	30	50	65
	(3s)	[kA]	25	30	30	65
Rated short-circuit making capacity (peak value) I_{cm}	1000V	[kA]	53	53	105	143
	1150V	[kA]	53	53	105	143

6.1.13 Tmax molded-case circuit-breakers for direct current applications

The molded-case circuit-breakers of Tmax T series complying with the Std. IEC 60947-2 are equipped with thermomagnetic trip units, have breaking capacities up to 150 kA (at 250V DC with two poles in series). The minimum service voltage is 24V DC.



The available circuit-breakers are¹:

- Tmax T5 and T6 equipped with thermomagnetic trip units TMA with adjustable thermal ($I_1 = 0.7..1 \times I_n$) and magnetic ($I_3 = 5..10 \times I_n$)² thresholds.

¹ As regards the modality of pole connection according to the network type and to the service voltage, please refer to the tables shown in the QT5 "ABB circuit-breakers for direct current applications".

² The value of the trip threshold varies according to the connection modality of the poles. For further information please refer to the technical product catalogue.

	T5					T6				
Rated uninterrupted current I_u [A]	400/630					630/800/1000				
Poles [Nr.]	3/4					3/4				
Rated service voltage U_e [V] (DC)	750					750				
Rated impulse withstand voltage U_{imp} [kV]	8					8				
Rated insulation voltage U_i [V]	1000					1000				
Test voltage at industrial frequency for 1 min. [V]	3500					3500				
Rated ultimate short-circuit breaking capacity I_{cu}	N	S	H	L	V	N	S	H	L	
	(DC) 250V - 2 poles in series [kA]	36	50	70	100	150	36	50	70	100
(DC) 250V - 3 poles in series [kA]	-	-	-	-	-	-	-	-	-	
(DC) 500V - 2 poles in series [kA]	25	36	50	70	100	20	35	50	65	
(DC) 500V - 3 poles in series [kA]	-	-	-	-	-	-	-	-	-	
(DC) 750V - 3 poles in series [kA]	16	25	36	50	70	16	20	36	50	
Utilization category (IEC 60947-2)	B (400A) ⁽¹⁾ A (630A)					B (630A-800A) ⁽²⁾ A (1000A)				
Isolation behaviour	■					■				
Trip units: thermomagnetic										
T adjustable, M adjustable (5..10 x I_n) TMA	■ (up to 500A)					■ (up to 800A)				
Interchangeability	■					■				
Versions	F-P-W					F-W				

⁽¹⁾ $I_{cw} = 5kA$

⁽²⁾ $I_{cw} = 7.6kA$ (630A) - 10kA (800A)

6.1.14 SACE Tmax molded-case circuit-breakers for direct current applications

ABB offers also the new series of molded-case circuit-breakers SACE Tmax XT up to 250A.

For the protection of the DC section of PV installations the following circuit-breakers are available:

- XT1 160 and XT3 250 equipped with thermomagnetic trip units TMD with adjustable thermal threshold ($I_1 = 0.7..1 \times I_n$) and fixed magnetic threshold ($I_3 = 10 \times I_n$);
- XT2 160 and XT4 250 equipped with thermomagnetic trip units TMA (for $I_n \geq 40A$) with adjustable thermal threshold ($I_1 = 0.7..1 \times I_n$) and magnetic threshold I_3 adjustable in the range $8..10 \times I_n$ for 40A, $6..10 \times I_n$ for 50A and $5..10 \times I_n$ for $I_n \geq 63A$.

		XT1				XT2				XT3				XT4				
Size	[A]	160				160				250				160/250				
Poles	[Nr.]	3/4				3/4				3/4				3/4				
Rated service voltage Ue	[V] (DC)	500				500				500				500				
Rated impulse withstand voltage Uimp	[kV]	8				8				8				8				
Rated insulation voltage Ui	[V]	800				1000				800				1000				
Rated ultimate short-circuit breaking capacity Icu		B	C	N	S	H	N	S	H	L	V	N	S	N	S	H	L	V
(DC) 250V-2 poles in series	[kA]	18	25	36	50	70	36	50	70	120	150	36	50	36	50	70	120	-
(DC) 500V-3 poles in series	[kA]	18	25	36	50	70	36	50	70	120	150	36	50	36	50	70	120	-
Utilization category (IEC 60947-2)		A				A				A				A				
Isolation behaviour		■				■				■				■				
Trip units: thermomagnetic		■				■				■				■				
T adjustable, M fixed TMD		■				■ (up to 32A)				■				■ (up to 32A)				
T adjustable, M adjustable TMA		-				■				-				■				
magnetic only MF/MA		-				■				■				■				
electronic Ekip		-				■				-				■				
Versions		F-P				F-P-W				F-P				F-P-W				

⁽¹⁾ For XT4 160A

⁽²⁾ For XT4 250A

6.1.15 Molded-case circuit-breakers for applications up to 1000V DC

The panorama of the Tmax T solutions includes also the circuit-breakers T4, T5 and T6 for direct current applications up to 1000V.

These circuit-breakers are available in the three-pole and four-pole version with TMD or TMA thermomagnetic trip units.

These circuit-breakers are available in fixed, plug-in and withdrawable version (for this the use of the 1000V fixed parts which can be supplied by the upper terminals only is required) and comply with all accessories except for the residual current release.

		T4	T5	T6
Rated uninterrupted current Iu	[A]	250	400/630	630/800
Poles		4	4	4
Rated service voltage Ue	[V]	1000	1000	1000
Rated impulse withstand voltage Uimp	[kV]	8	8	8
Rated insulation voltage Ui	[V]	1150	1150	1000
Test voltage at industrial frequency for 1 min.	[V]	3500	3500	3500
Rated ultimate short-circuit breaking capacity Icu		V ⁽¹⁾	V ⁽¹⁾	L ⁽¹⁾
(DC) 4 poles in series	[kA]	40	40	40
Utilization category (IEC 60947-2)		A	B (400A) ⁽²⁾ - A (630A)	B ⁽³⁾
Isolation behaviour		■	■	■
Trip units: thermomagnetic				
T adjustable, M fixed TMD		■	-	-
T adjustable, M adjustable (5..10 x In) TMA		■	■	■
Versions		F	F	F ⁽⁴⁾

⁽¹⁾ Supply from the top only

⁽²⁾ $I_{cw} = 5kA$

⁽³⁾ $I_{cw} = 7.6kA (630A) - 10kA (800A)$

⁽⁴⁾ Tmax T5 630 is available in the fixed version only

⁽⁵⁾ For T6 in the withdrawable version ask ABB

Thermomagnetic trip units for applications up to 1000V DC – TMD and TMA

In [A]	T4 250	T5 400-630	T6 630-800
	TMD/TMA	TMA	TMA
32	■		
50	■		
80	■		
100	■		
125	■		
160	■		
200	■		
250	■		
320		■	
400		■	
500		■	
630			■
800			■

6.1.16 Tmax PV molded-case circuit-breakers for direct current applications

Tmax PV is a series of T generation. They are circuit-breakers for direct current applications with high values, suitable to be installed in photovoltaic plants. They comply with both IEC as well as UL.

In compliance with the Std. IEC 60947-3, Tmax PV range offers the version of switch-disconnectors at 1100V DC and a new version at 1500V DC; connection jumpers are also available to increase safety and ease of installation.

In compliance with the Std. UL489B, Tmax PV range offers not only switch-disconnectors, but also automatic circuit-breakers.

The connection jumpers required for Tmax PV UL ensure simplicity and ease of use and guarantee compliance with the new UL standards.



Molded-case switch-disconnectors at 1000V DC, in compliance with Std. IEC 60947-3

		T1D/ PV	T3D/ PV	T4D/ PV	T5D/ PV	T6D/ PV	T7D/ PV
Size	(A)	160	250	250	630	800	1250-1600
Rated service current in category DC22 B	(A)	160	200	250	500	800	1250-1600
Poles	(No.)	4	4	4	4	4	4
Rated service voltage	(V DC)	1100	1100	1100	1100	1100	1100
Rated short-time withstand current	(kA)	1.92	2.4	3	6	9.6	19.2

Molded-case switch-disconnectors at 1500V DC, in compliance with Std. IEC 60947-3

		T4D/PV	T7D/PV
Size	(A)	250	1250-1600
Rated service current in category DC22 B	(A)	250	1250-1600
Poles	(No.)	4	4
Rated service voltage	(V DC)	1500	1500
Rated short-time withstand current	(kA)	3	19.2

Molded-case switch-disconnectors at 1000V DC, in compliance with Std. UL 489B

		T1N-D/ PV	T4N-D/ PV	T5N-D/ PV	T6N-D/ PV	T7N-D/ PV
Size	(A)	100	200	400	600-800	1000
Rated service current	(A)	100	200	400	600-800	1000
Poles	(No.)	4	3	3	4	4
Rated service voltage	(V DC)	1000	1000	1000	1000	1000
Rated short-time withstand current	(kA)	1	3	5	10	15
Override	(kA)	-	3	5	10	-

Molded-case circuit-breakers at 1000V DC, in compliance with Std. UL 489B

		T4N-D/PV	T5N-D/PV	T6N-D/PV
Size	(A)	200	400	600-800
Rated service current	(A)	40-200	400	600-800
Poles	(No.)	3	3	4
Rated service voltage	(V DC)	1000	1000	1000
Breaking capacity	(kA)	3	5	10
Trip units		TMD/TMA	TMA	TMA

Note:

For wiring configurations and for further technical information please refer to the catalogue and to the installation instructions.

If a polarity on the inverter side is connected to ground, ask ABB the proper size of the fuse and the configuration of the CB poles.

6.1.17 Air circuit-breakers for direct current applications

Air circuit-breakers of Emax series comply with the Std. IEC 60947-2 and are equipped with DC electronic trip units type PR122/DC and PR123/DC.

They have an application field ranging from 800A (with E2) to 5000A (with E6) and breaking capacities from 35kA to 100kA (at 500V DC).

By connecting three poles in series, it is possible to achieve the rated voltage of 750V DC, while with four poles in series the limit raises to 1000V DC².

The minimum operational voltage (supplied by the dedicated low voltage measuring module PR120/LV) is 24V DC. Thanks to their unique technology, the trip units type PR122/DC-PR123/DC allow the protection functions already available in alternating current to be carried out. The Emax DC range maintains the same electrical and

mechanical accessories in common with the Emax range for alternating current applications.



²As regards the compulsory modality of pole connection according to the network typology and to the service voltage, please refer to the schemes shown in the QT5 "ABB circuit-breakers for direct current applications".

		E2		E3		E4		E6
Rated service voltage Ue	[V]	1000		1000		1000		1000
Rated impulse withstand voltage Uimp	[kV]	12		12		12		12
Rated insulation voltage Ui	[V]	1000		1000		1000		1000
Poles	[Nr.]	3/4		3/4		3/4		3/4
Rated uninterrupted current Iu		B	N	N	H	S	H	H
	[A]	800		800				
	[A]	1000		1000				
	[A]	1250		1250				
	[A]	1600	1600	1600	1600	1600		
	[A]			2000	2000	2000		
	[A]			2500	2500	2500		
	[A]					3200	3200	3200
	[A]							4000
[A]							5000	
Rated short-time withstand current for (0.5s) Icw	[kA]							
	500V DC (II)	35	50	60	65	75	100	100
	750V DC (III)	25	25	40	40	65	65	65
	750V DC (II)	25	40	50	50	65	65	65
	1000V DC (IV)	25	25	35	40	50	65	65
Utilization category (IEC 60947-2)		B	B	B	B	B	B	B
Isolation behaviour		■		■		■		■
Versions		F-W		F-W		F-W		F-W

Network isolated ⁽¹⁾

Rated voltage (Un)			≤ 500	≤ 750		≤ 1000
isolation			■	■	■	■
protection			■	■	■	■
PR122/DC			■	■	■	■
PR123/DC			■	■	■	■
I _{cu} ⁽²⁾			[kA]	[kA]	[kA]	[kA]
E2	B	800	35	25	25	25
		1000				
		1250				
		1600				
	N	1600	50	25	40	25
E3	N	800	60	40	50	35
		1000				
		1250				
		1600				
		2000				
	2500					
H	1600	65 ⁽³⁾	40	50	40	
2000						
2500						
E4	S	1600	75	65	65	50
		2000				
		2500				
		3200				
	H	3200	100	65	65	65
E6	H	3200	100	65	65	65
		4000				
		5000				

⁽¹⁾ With this type of pole connections the likelihood of a double fault to earth is to be considered negligible. For further information see QT5: "ABB circuit-breakers for direct current applications".

⁽²⁾ I_{cu} with L/R = 15ms in compliance with IEC 60946-2. As regards the I_{cu} values with L/R = 5ms and L/R = 30ms please ask ABB.

⁽³⁾ 85kA, only if supplied from below and by specifying in the order the following extra code: 1SDA067148R1. I_{cs}=65kA.

Network with the midpoint connected to earth

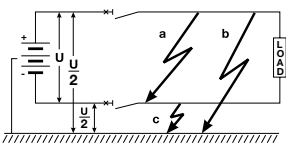
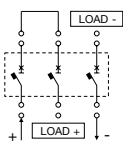
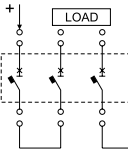
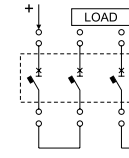
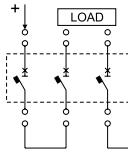
Rated voltage (Un)			≤ 500			≤ 500			≤ 750			≤ 1000		
														
PR122/DC			-			-			-			-		
PR123/DC			■			■			■			■		
fault typology			a	b	c	a	b	c	a	b	c	a	b	c
poles in series affected by the fault			3	2 (U/2)	1 (U/2)	3	2 (U/2)	2 (U/2)	3	2 (U/2)	2 (U/2)	3	2 (U/2)	2 (U/2)
I _{cu} ⁽¹⁾			[kA]			[kA]			[kA]			[kA]		
E2	B	800	35	35	18	35	35	35	25	25	25	25	25	25
		1000												
		1250												
		1600												
	N	1600	50	50	25	50	50	50	40	40	40	25	25	25
E3	N	800	60	60	30	60	60	60	50	50	50	35	35	35
		1000												
		1250												
		1600												
		2000												
	2500													
H	1600	65 ⁽²⁾	65	40	65 ⁽²⁾	65 ⁽²⁾	65 ⁽²⁾	50	50	50	40	40	40	
E4	S	1600	75	75	35	75	75	75	65	65	65	50	50	50
		2000												
		2500												
		3200												
	H	3200	100	100	50	100	100	100	65	65	65	65	65	65
E6	H	3200	100	100	65	100	100	100	65	65	65	65	65	65
		4000												
		5000												

⁽¹⁾ I_{cu} with L/R = 15ms in compliance with IEC 60946-2. As regards the I_{cu} values with L/R = 5ms and L/R = 30ms please ask ABB.

⁽²⁾ 85kA only if supplied from below and by specifying in the order the following extra code: 1SDA067148R1.

Network with a negative polarity connected to earth ⁽¹⁾

Rated voltage (Un)			≤ 500 ⁽²⁾			
isolation			■		■	
protection			■		■	
PR122/DC			■		■	
PR123/DC			■		■	
fault typology ⁽³⁾			a		b	
poles in series affected by the fault			3		2	
Icu ⁽⁴⁾			[kA]		[kA]	
E2	B	800	35	20	25	25
		1000				
		1250				
		1600				
N	1600	50	25	40	25	
	800	60	30	50	35	
N	1000					
	1250					
	1600					
	2000					
H	2500					65 ⁽⁵⁾
	1600					
	2000					
E4	S	1600	100	50	100	100
		2000				
		2500				
		3200				
H	3200	100	65	100	100	
E6	H	3200	100	65	100	100
		4000				
		5000				

⁽¹⁾ For networks with grounded positive polarity please ask ABB.

⁽²⁾ For higher voltage values please ask ABB.

⁽³⁾ For further information see QT5: "ABB circuit-breakers for direct current applications".

⁽⁴⁾ I_{cu} with L/R = 15ms in compliance with IEC 60946-2. As regards the I_{cu} values with L/R = 5ms and L/R = 30ms please ask ABB.

⁽⁵⁾ 85kA only if supplied from below and by specifying in the order the following extra code: 1SDA067148R1. I_{cs}=65kA.

6.1.18 Air switch-disconnectors for applications up to 1000V DC

Emax/E MS are switch-disconnectors for applications up to 1000V DC and 6300A DC.

They are available either fixed or withdrawable, in both three- and four-pole versions.

By connecting three breaking poles in series, it is possible to achieve a rated voltage of 750V DC, while with four poles in series the rated voltage is 1000V DC.

		E1B/E MS		E2N/E MS		E3H/E MS		E4H/E MS		E6H/E MS	
Rated service voltage Ue	[V]	750	1000	750	1000	750	1000	750	1000	750	1000
Rated impulse withstand voltage Uimp	[kV]	12	12	12	12	12	12	12	12	12	12
Rated insulation voltage Ui	[V]	1000	1000	1000	1000	1000	1000	1000	1000	1000	1000
Poles	[Nr.]	3	4	3	4	3	4	3	4	3	4
Rated uninterrupted current Iu	[A]	800		1250		1250		3200		4000	
	[A]	1250		1600		1600		4000		5000	
	[A]			2000		2000				6300	
	[A]					2500					
	[A]					3200					
Rated short-time withstand current for (1s) Icw	[kA]	20	20*	25	25*	40	40*	65	65	65	65

Note: the breaking capacity I_{cu} when using an external release with 500ms maximum time delay is equal to the I_{cw} value (1s).

*The performances at 750V are:

for E1B/E MS $I_{cw} = 25$ kA

for E2N/E MS $I_{cw} = 40$ kA

for E3H/E MS $I_{cw} = 50$ kA

6.1.19 New air switch-disconnectors for applications up to 1000V DC.

ABB extends the new range of air circuit-breakers to include also direct current applications thanks to the switch-disconnectors for applications up to 1000V in

compliance with the international Standard IEC 60947-3. For all those applications requiring also integrated protection in addition to disconnection, ABB offers the automatic circuit-breakers SACE Emax with PR122/DC and PR123/DC.

Common data		
Rated service voltage Ue	[V]	750 (3p) / 1000 (4p)
Rated insulation voltage Ui	[V]	1000
Rated impulse withstand voltage Uimp	[kV]	12
Number of poles		3 - 4
Version		Fissa - Estraibile
Isolation behaviour		IEC 60947-3



SACE Emax 2			E1.2			E2.2			E4.2			E6.2		
Performance levels			N/DC MS			S/DC MS			H/DC MS			X/DC MS		
Rated uninterrupted current Iu @ 40°C	[A]		800			1250			1250			4000		
	[A]		1250			1600			1600			5000		
	[A]					2000			2000			6300		
	[A]					2500			2500					
	[A]								3200					
	[A]								4000					
Poles			3	4	4	3	4	4	3	4	4	3	4	4
Rated service voltage Ue			750	750	1000	750	750	1000	750	750	1000	750	750	1000
Rated insulation voltage Ui			1000	1000	1000	1000	1000	1000	1000	1000	1000	1000	1000	1000
Rated short-time withstand current Icw	(1s)	[kA]	20	25	20	25	40	25	40	50	40	65	65	65
Rated short-circuit making capacity (peak value) Icm	750V	[kA]	40	53	40	53	84	53	84	105	84	143	143	143
	1000V	[kA]			40			53			84			143
Utilization category (according to IEC 60947-3)														

6.2 Residual current releases Type B

6.2.1 Residual current releases RC223 and RC Type B

The RC223 residual current release, which can be combined with Tmax T3 and T4 four-pole circuit-breakers in the fixed, withdrawable or plug-in version (withdrawable and plug-in for T4 only), and the residual current release RC Type B, which can be combined with Tmax T3 four-pole circuit-breaker, are the most advanced solution in the residual current release family for Tmax T and SACE Tmax XT range.

It can boast conformity with Type B operation, and therefore guarantees sensitivity to residual fault currents with alternating, alternating pulsating and direct current components.

Apart from the signals and settings typical of the “basic” residual current release, RC223 and RC Type B releases allow also the selection of the maximum threshold of sensitivity at the residual fault frequency (3 steps: 400–700 – 1000 Hz).

It is therefore possible to adapt the residual current device to the different requirements of industrial plants

according to the prospective fault frequencies generated on the load side of the release.



RC223



RC B Type

Electrical characteristics		RC223	RC B Type
Primary service voltage	[V]	110...500	110...500
Rated frequency	[Hz]	45...66	45...66
Fault current frequency	[Hz]	0-400-700-1000	0-400-700-1000
Rated service current	[A]	fino a 250A (225 per T3)	fino a 225A
Adjustable trip thresholds	[A]	0.03-0.05-0.1-0.3-0.5-1	0.03-0.05-0.1-0.3-0.5-1
Adjustable time limits for non-trip at 2·I _n	[s]	ist-0.1-0.2-0.3-0.5-1-2-3	ist-0.1-0.2-0.3-0.5-1-2-3
Absorbed power		<10W @ 400V	<10W @ 500V

6.2.2 Residual Current Devices

Residual Current Circuit-Breakers (RCCBs) F200, F204 B, F202 PV-B

Residual current circuit-breakers type B are also sensitive to fault currents with a low ripple level, similar to continuous fault currents.

They however remain sensitive to sinusoidal alternating and pulsating continuous earth fault currents. When a photovoltaic plant includes an inverter without at least a simple DC/AC separation, it's necessary to install on DC side an RCBO of B class, according to IEC 60364-7 art. 712.413.1.1.1.2: "Where an electrical installation includes a PV power supply system without at least simple separation between the AC side and the DC side, an RCD installed to provide fault protection by automatic disconnection of supply should be type B. If the PV inverter by construction is not able to feed DC fault current into the electrical installation a B-type RCD is not mandatory".

Main technical specifications	F200 type B
Rated current I_n	25, 40, 63, 125 A
Rated sensitivity $I_{\Delta n}$	0.03 - 0.3 - 0.5 A
Operating frequency range	0 - 1000 Hz
Minimum supply voltage	
- to detect currents of type A / AC	0 V
- to detect currents of type B	30 VAC
Number of poles	2P, 4P
Conditional short-circuit current I_{nc}	10 kA
Conditional residual short-circuit current $I_{\Delta c}$	10 kA
IP Class	IP40 (when installed into a switchboard)
Operating temperature	-25°C...+40°C
Reference standards	IEC 62423 ed. 2



F200 A

On the other hand, in case a DC/AC electrical separation exists, residual current circuit breaker type A can be used.

Main technical specifications	F200 A
Reference Standard	Standard IEC/EN 61008
Nominal Current (I_n)	16 ... 125 A
Nominal Voltage (U_e)	230...400 VAC
Sensitivity	10 - 30 - 100 - 300 - 500 mA
Number of poles	2P, 4P
Operation Temperature	-25...+55°C



Residual Current Devices (RCDs) DDA200 type B

DDA202 B, DDA203 B and DDA204 B RCD-blocks type B are also sensitive to fault currents with a low level ripple similar to continuous fault currents. If used in combination with S200 series MCBs, they assure the protection of people and installations against fire risks, short circuit and overcurrents. They however remain sensitive to sinusoidal alternating and pulsating continuous earth fault currents. When a electrical system includes a PV power system without at least a simple DC/AC separation, the residual device installed to provide protection against indirect contact by automatic supply disconnection must be of type B according to IEC 62423 ed.2 (IEC 60364-7 art. 712.413.1.1.1.2) standard.

Main technical specifications	DDA200 type B
Type	B (instantaneous) and B S (selective)
Rated current I_n	25, 40, 63 A
Rated sensitivity $I_{\Delta n}$	0.03 - 0.3 - 0.5 A
Operating frequency range	0 - 1000 Hz
Operating voltage	230...400 V
Number of poles	2P - 3P - 4P
Ambient temperature	-25...+55 °C
Reference standards	IEC 61009 Annex G, IEC 62423 ed.2



6.3 Contactors (for DC switching)

GAF contactors

The GAF range is dedicated to DC switching. Based on the A range, these are reliable and modern contactors.* When DC voltage and/or current ratings higher than below table, ABB offers bar contactors, designed by customer specification.

Main technical specifications

Rated operational voltage	GAF	1000 VDC
Current ratings, DC-1		275 – 2050 A
Control voltage		Electronically controlled AC/DC
Number of poles		3 (connect in series)
Reference standards		IEC60947-1, -4-1



IOR bar contactors

IOR..-CC, IORR..-CC, IORE..-CC and IORC..-CC contactors with increased insulation, are used for controlling d.c. power circuits, at voltages $U_e \leq 1500$ V d.c. (time constant $L/R \leq 7.5$ ms). (For operational voltage $U_e > 1500$ V d.c. or time constant $L/R > 7.5$ ms: please contact us). The poles must be connected in series. For 63 to 500 A contactor ratings, the blow-out coil will be rated as the actual service current rating.
Auxiliary contacts: 1 N.O. + 1 N.C. available.

Main technical specifications

Rated operational current $U_e \leq 1500$ V d.c.			
Number of poles 3			
IOR..-CC, IORR..-CC contactors (a.c. operated)	DC-1	A	85, 170, 275, 550, 800, 1500, 1800
	DC-3/DC-5	A	68, 125, 205, 500, 720
IORE..-CC contactors (d.c. operated - with economy resistor)	DC-1	A	85, 170, 275, 550, 800, 1500, 1800
	DC-3/DC-5	A	68, 125, 205, 500, 720
IORC..-CC contactors (d.c. operated - without economy resistor)	DC-1	A	85, 170, 275, 550, 800
	DC-3/DC-5	A	68, 125, 205, 500, 720

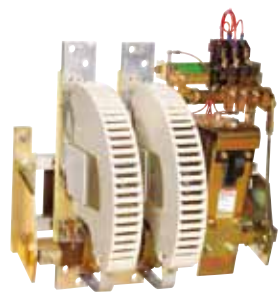

Standard A and AF range

The A and AF ranges are standard, general purpose block contactors for reliable remote switching of both AC and DC circuits.

Main technical specifications	A9-AF2050
Rated operational voltage	1000 V
Current ratings	9 – 2050A (AC) max 1900A DC at 600 V according to cULus
Control voltage, A range	Direct operation, AC or DC
Control voltage, AF range	Electronically controlled AC/DC
Number of poles	3
Reference standards	IEC60947-1, -4-1



Main technical specifications

Reference Standards	OTDC16...32 CEI EN 60947-3
Nominal current I_n A	16, 25, 32
Nominal current I_e A	16/2, 25/2, 32/2
Number of poles ($U_e=600$ VDC)	16/2x2, 25/2x2, 32/2x2
Nominal current I_e A	10/2, 16/2, 20/2
Number of poles ($U_e=1000$ VDC)	16/3, 25/3, 32/3
	10/2x2, 16/2x2, 20/2x2
Class of use	DC-21B
Maximum operating temperature in box without I_{th}^* derating °C	60
Mounting	With screws on the bottom of the switchboard or on DIN rail EN 60715 (35 mm) by means of fast clip device

*Minimum cable size of 4, 6 and 10 mm² respectively



6.4 Switch-disconnectors

OTDC 16...32

OTDC switch-disconnectors are available with nominal currents from 16A up to 32A in three different modular versions, with the same frontal footprint and one, two or three arc plates depending on operating DC voltage. The main features of the OTDC switch-disconnectors include:

- Compactness and modularity: allow for switchboard dimension and costs reduction
- Thermal efficiency: low resistive losses for reduced heat dispersion, avoiding waste of energy
- High operating voltages: the in-depth development of arc plates allows to reach insulating voltages up to 1000V
- Rail mounting for easy installation
- DIN, tunnel terminals and jumpers for parallel wiring included: easy and quick assembly
- OTDC from 16 to 32 A is also available in a plastic enclosure (OTDCP), suitable for outdoor use.

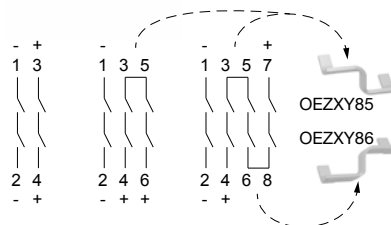

Wiring diagram

Switch-disconnectors OTDC100...250

OTDC100...250 series of switch-disconnectors is available with nominal currents from 100A up to 250A in single footprint with two poles (1000 VDC version).

Four pole (1500 VDC) or double device versions (two devices operated simultaneously by a single handle) are available.

The main features of the OTDC100...250 switch-disconnectors include:

- Compactness: thanks to the patented DMB (Dual Magnetic Breaking) technology are the first switch-disconnectors in the market to reach 1000 VDC with only 2 poles (front footprint WxH 113x176)
- Easy to install: connections are independent from polarity, for a greater wiring flexibility. The command mechanism can be located between the poles or on the left side of the switch
- Safety: visible contacts allow a clear indication of switch status

Main technical specifications

Reference Standards	OTDC100...250 IEC EN 60947-3 UL98B
Nominal current In A	100,160,200,250 (IEC EN 60947-3) 100, 180, 200 (UL98B)
Number of poles	2, 4
Nominal voltage Ue (DC) 2 poles V	1000
(DC) 4 poles V	1500
(DC) 4 poles (2X2) V	1000
Class of use	DC-21B
Maximum operating temperature in box without I _{th} *derating °C	40
Mounting	With screws on the bottom of the switchboard



Wiring diagram

Switch-disconnectors OTDC250...500

The OTDC series of switch-disconnectors is available with nominal currents from 250 to 500 A, in single footprint with two poles (1000 VDC).

Three pole (1500 VDC) or double device versions (two devices operated simultaneously by a single handle) are available.

The main features of the OTDC250...500 switch-disconnectors include:

- Compactness: thanks to the patented DMB (Dual Magnetic Breaking) technology, the switches reach 1000 VDC with only 2 poles. The front footprint is WxH 197 X 227.
- Easy to install: connections are independent from polarity, for a greater wiring flexibility. The command mechanism can be located between the poles or on the left side of the switch
- Safety: visible contacts allow a clear indication of switch status.

Main technical specifications

Reference Standards	OTDC250...500 IEC EN 60947-3 UL98B
Nominal current In A	315, 400, 500 (IEC EN 60947-3) 250, 320, 400 (UL98B)
Number of poles	2, 3, 4
Nominal voltage Ue (DC) 2 poles V	1000
(DC) 4 poles V	1500
(DC) 4 poles (2X2) V	1000
Class of use	DC-21B
Maximum operating temperature in box without I _{th} *derating °C	40
Mounting	With screws on the bottom of the switchboard



Wiring diagram

Switch-disconnectors OT_M

The rotary switch-disconnectors of OT_M series are specially designed for quick-disconnection of electrical lines according to IEC 60947-3 standard; they are used to control and insulate strings up to 750 VDC and offer an ideal complement for a safety maintenance of FV systems.

The main features of the OT_M switch-disconnectors include:

- quick-make and quick-break operations with independent snap function
- available options include auxiliary contacts and knobs for remoted rotary command
- Integrated with the System pro M compact product line and compatible with OT series accessories
- Versions over 40 A with pad lockable door locking knob

Main technical specifications

		OT_M		
Reference Standards		IEC EN 60947-3		
Nominal current I_n		40, 80, 125 A		
Number of poles		3, 4		
Switch-disconnector		40M_	63ML_	125M_
Nominal Operating Current in DC-21A/ series poles				
500 VDC	A	16/4	16/4	20/4
750 VDC	A	-	-	-
Class of use		DC-21A		
Operating temperature °C		-25...+50		
Mounting		on DIN rail EN 60715 (35 mm) by means of fast clip device		

* Refer to wiring diagrams

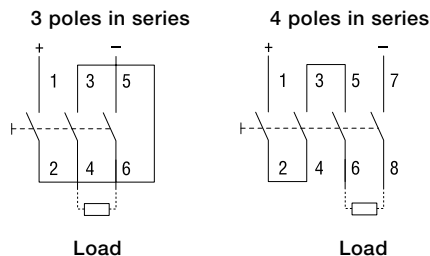

OT series

The OT series of switch-disconnectors from ABB has been the industry standard in traditional AC applications for many years. They are a perfect solution for the AC side of solar applications.

OT switch-disconnectors are not only among the most compact in the market, but they also offer high technical ratings.

The main features include:

- Full range to cover any application up to 3800 A
- Door, base or DIN-rail mounting, flexible installation in any direction
- Wide selection of accessories
- Small frames save money as less space is needed
- Remote control with motorized versions (OTM_)

Main technical specifications

		OT
Reference standard		IEC 60947-3
		UL 508 & UL 98
Nominal voltage, U_e		up to 690 V
Nominal current, I_n		16 - 4000 A (IEC)
		20 - 2000 A (UL)
Number of poles		2, 3, 4
Mounting		Base, DIN rail and door mounting



Switch-disconnectors S800 PV-M

The S800 PV-M modular switch-disconnectors can be used in networks up to 1200 V DC (4-poles execution). Together with its range of accessories (auxiliary contacts, undervoltage releases, motorized commands) allow for a wide spectrum of configurations.

The main features of the S800 PV-M switch-disconnectors include:

- interchangeable terminals
- contact status displayed for each pole
- polarity independent wiring

Main technical specifications	S800 PV-M	
Reference Standards	EC EN 60947-3	
Rated current In A	25	32, 63, 125
Number of poles	2	2, 4
Rated voltage Ue (DC) 2 poles* V kA	650	800
(DC) 4 poles* V kA	-	1200
Rated short-time withstand current Icw (DC) 2 poles* 800 V kA	1.5	
(DC) 4 poles* 1200 V kA	1.5	
Class of use	DC-21A	
Operating temperature °C	-25...+60	
Mounting	on DIN rail EN 60715 (35 mm) by means of fast clip device	

*Please refer to the wiring diagrams

Panel network in earth-insulated systems

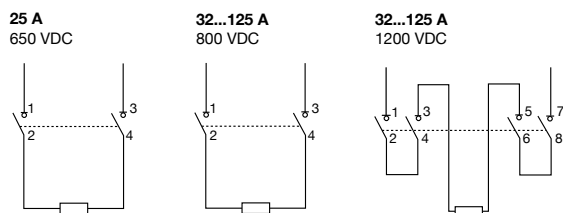

Polarized switch-disconnectors S802 PV-M-H

The S802 PV-M-H polarized switch-disconnectors are specially designed for networks up to 1000 VDC.

They are equipped with permanent magnets which provide the switch polarity, therefore a correct supply voltage is required. S802 PV-M-H switch-disconnectors and its range of accessories (auxiliary contacts, undervoltage releases, motorized commands) allow for a wide spectrum of configurations.

The main features of the S802 PV-M-H switch-disconnectors include:

- interchangeable terminals
- contact status displayed for each pole

Main technical specifications	S802 PV-M-H
Reference Standards	CEI EN 60947-3
Rated current In A	32, 63, 100
Number of poles	2
Rated voltage Ue (DC) 2 poles* V	1000
Rated short-time withstand current Icw (DC) 2 poles* 1000 V kA	1,5
Class of use	DC-21A
Operating temperature °C	-25...+60
Mounting	on DIN rail EN 60715 (35 mm) by means of fast clip device

*Please refer to the wiring diagrams

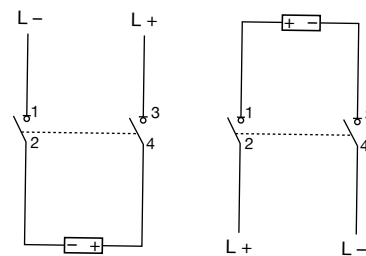

Comply with polarity and supply direction in wiring.



6.5 Miniature circuit-breakers

S800 PV-S

The S800 PV-S modular miniature circuit-breakers can be used in networks up to 1200 VDC (4-poles execution). The S800 PV-S circuit breakers and its range of accessories (auxiliary contacts, undervoltage releases, motorized commands) allow for a wide spectrum of configurations. The main features of the S800 PV-S circuit breakers include:

- interchangeable terminals
- central trip safe disconnection of all poles
- contact status displayed for each pole
- polarity independent wiring

Main technical specifications

Reference Standards	S800 PV-S	
	CEI EN 60947-3	
Rated current I_n A	10...80	100, 125
Number of poles	2, 4	
Rated voltage U_e (DC) 2 poles* V	800	600
(DC) 4 poles* V	1200	1200
Ultimate rated short-circuit breaking capacity I_{cu} (DC) 2 poles 800 V* kA	5	5
(DC) 4 poles* 1200 V kA	5	5

Thermomagnetic release characteristic
Class of use
Operating temperature °C
Mounting

$4 I_n \leq I_m \leq 7 I_n$
A
-25...+60
DIN rail EN 60715
(35 mm) by means of fast clip device

*Please refer to the wiring diagrams

Panel network in earth-insulated systems $\leq 80A$

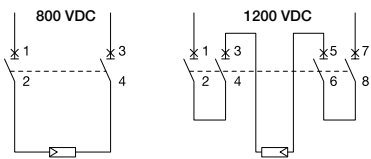

100, 125A

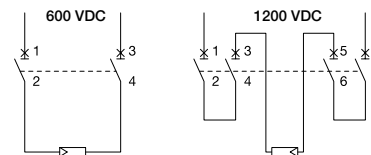

S204 M UC Z

The S200 M UC Z range of miniature circuit-breakers features permanent magnets on the internal arcing chutes able to extinguish an electric arc of up to 500 V DC with $I_{cu} = 4.5$ kA. However, use of these components establishes circuit-breaker polarity, thus they must be powered in a certain direction. A diagram showing how the string and inverter must be connected is given alongside.

Main technical specifications

	S204 M UCZ
Rated current I_n A	$0,5 \leq I_n \leq 63$
Number of poles	4
Rated voltage U_e (DC) V	440
Ultimate rated breaking capacity I_{cu} - 4P kA	10
Electromagnetic release	$3 I_n \leq I_m \leq 4,5 I_n$
Operating temperature °C	-25...+55
Mounting	on DIN rail EN 60715 (35 mm) by means of fast clip device

In IT systems an isolation monitoring device should not be

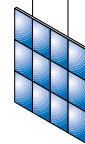
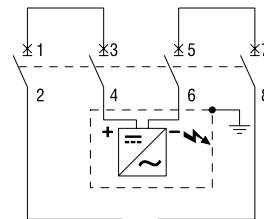

Photovoltaic panels



6.6 String monitoring

Current Measurement System (CMS)

The CMS string monitoring increases the efficiency of your photovoltaic system. The easy-to-integrate system enables you to immediately detect either a defective string or a loss in performance, e.g., caused by contaminated or damaged panels and to quickly implement appropriate countermeasures. Main use is for string monitoring in combiner boxes to detect failures on PV strings.









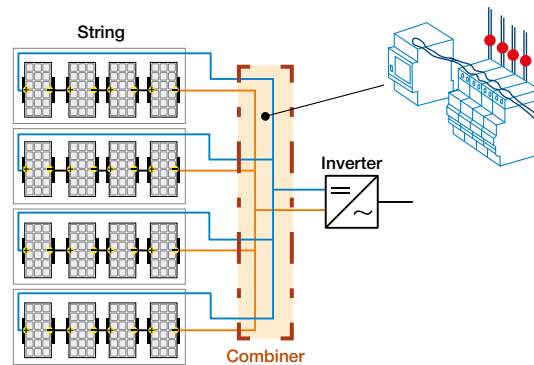















Benefits:

- small sizes
- high accuracy
- quick installation start up time
- freely selectable amount of measurement points

Main technical specification

	CMS
Measurement range CMS-100 Series (18mm Sensor) A	80, 40, 20
Measurement range CMS-200 Series (25mm Sensor) A	160, 80, 40
Insulation Voltage V	1500 VDC
DC Accuracy (TA = +25 °C) %	0,7 – 1,7
Operating temperature °C	-25 .. +70
Communication	-Modbus RTU (RS485 2 wire)



Mounting	S800	DIN rail	Cable Ties
	for all ABB S800 devices with cage terminals 	universal use 	universal use 
18mm	CMS-100S8 	CMS-100DR 	CMS-100CA 
	CMS-101S8 	CMS-101DR 	CMS-101CA 
	CMS-102S8 	CMS-102DR 	CMS-102CA 
25mm	CMS-200S8 	CMS-200DR 	CMS-200CA 
	CMS-201S8 	CMS-201DR 	CMS-201CA 
	CMS-202S8 	CMS-202DR 	CMS-202CA 
	CMS-203S8 	CMS-203DR 	CMS-203CA 

6.7 Surge protective devices

OVR PV

ABB offers a wide range of surge protection devices specifically designed for photovoltaic systems. The main features of the OVR PV SPDs include:

- OVR PV T1 and T2 version
- auto-protected from end-of-life short circuits up to 100 A DC thanks to the integrated thermal protection with direct current breaking capacity
- pluggable cartridges for easy maintenance, no need to disconnect the line
- auxiliary contact for remote signaling of line status ("TS" version)
- absence of short circuit follow current
- absence of risk for reversed polarity
- "Y" configuration for a safer protection

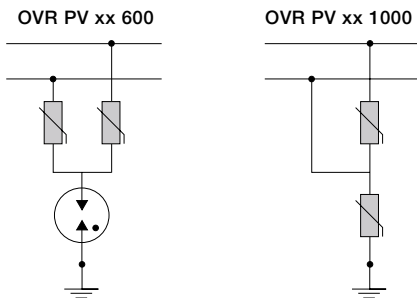

Main technical specification

	OVR PV T1	OVR PV 40
Reference standards	IEC 61643-11 / UTE C 61740-51 prEN 50539-11 UL 1449 3rd edition*	
Configuration	Y	Y
SPDs Type / Test Class	T1 / I	T2 / II
Max. cont. Operating voltage Ucpv	670 / 1000	670 / 1000
Nominal discharge current In (8/20 μs)	6.25	20
Impulse current Iimp (10/350 μs)	6.25	-
Maximum discharge current I _{max} (8/20 μs)	-	40
Voltage protection level Up	1.9 / 2.5	2.8 / 3.8
Short circuit DC current withstand I _{scwpv}	100	100
Back-up protection:		
- if I _{scwpv} ≤ 100A	- not required	- not required
- if I _{scwpv} > 100A	- 10A gPV fuse	- 10A gPV fuse or MCB
Response time	ns	≤25
Specific integrated PV thermal disconnecter	Yes	Yes
Pluggable	Yes	Yes
Auxiliary contact	TS	TS

*UL version only for OVR PV 40

OVR TC

With increasing request of monitoring systems, OVR TC data line SPDs are the right choice to protect the monitoring lines of the PV plants from surges. They are installed in series with the network and have removable cartridges, making maintenance simple, without having to cut the power to the telecommunications line.

Main technical specifications

Reference Standard	IEC/EN 61643-21 - UL497B
IEC type	C2
Max. cont. operating voltage U_c	V 7 to 220V (AC/DC)
Nominal Discharge current I_n (8/20us) kA	5
Max. discharge current I_{max} (8/20us) kA	10
Response time ns	1
Pluggable	Yes

OVR TC

OVR T1, OVR T2

To provide efficient protection for a photovoltaic system the alternate current side must also be protected against overvoltage.

OVR T1, Type-1 SPD, is installed in the main (AC side) switchboard at the system input and is able to conduct the direct lightning current to earth and to ensure safety in the case of a direct lightning strike.

OVR T2, Type-2 SPDs, are installed on the load side of the inverter and in possible other sub-switchboard to protect against switching surges and the indirect effect of lightning.

The main features of the OVR range are:

- Network configuration in single pole, 3 poles, 1 Phase+N and 3 Phases+N
- Simplified maintenance with the pluggable cartridges (P option)
- Increased security with the safety reserve (S option)
- Remote indication with the auxiliary contact (TS option).

Main technical specifications

	OVR T1	OVR T2
Reference standards	IEC EN 61643-11 / UL 1449 3rd edition*	
IEC Type	T1 / I	T2 / II
Max. cont. Operating Voltage U_c	V 255	275
Nominal discharge current I_n (8/20 μ s)	kA 15 and 25	5, 20 and 30
Impulse current I_{imp} I_n (10/350 μ s)	kA 15 and 25	/
Maximum discharge current I_{max} (8/20 μ s)	kA /	20, 40 and 70
Response time	ns < 100	< 25
Safety reserve	/	"S" Version
Pluggable	/	"P" Version
Remote indicator	"TS" Version	"TS" Version



6.8 Fuse disconnectors

E 90 PV

The E 90 PV series of fuse disconnectors has been designed for up to 1000 VDC applications in DC-20B category. The E 90 PV series is specifically focused on overcurrents protection of photovoltaic systems.

It provides a reliable, compact and effective solution due to its 10.3 x 38 mm gPV cylindrical fuses.

The main features of E 90 PV fuse disconnectors include:

- 90° opening handle for an easy insertion of fuse even wearing gloves or using the thumb
- Only 17 mm difference in depth between open and closed position
- 25 mm² terminals with knurled cage for a better cable clamp
- Fully compatible with electrical screwdrivers
- Pozidriv screws for flat or cross screwdrivers
- Lockable in open position through standard padlocks, for a safer maintenance
- Sealable in closed position with lead seals to prevent unauthorized access
- Cooling chambers and ventilation slots improve heat dissipation
- Available with indicator LED lights to signal if the fuse is blown

Main technical specifications

	E 90/32 PV
Reference Standards	IEC 60947-3, UL 4248-1, UL 4248-18
Rated Voltage V DC	1000
Utilization category	DC-20B
Fuse mm	10 x 38 gPV curve
Current	DC
Rated Current A	32
Tightening torque Nm	PZ2 2-2.5
Protection Class	IP20
Lockable (open position)	Yes
Sealable (closed position)	Yes



6.9 Cylindrical Fuses

E 9F PV

The new E 9F PV range of cylindrical fuses has been designed to protect DC circuits up to 1000 VDC according to gPV trip characteristic specific for PV systems. E 9F PV 10.3 x 38 mm fuses offer the best solution for protecting strings, inverters and surge arresters in photovoltaic systems with nominal currents up to 30 A.

Main technical specifications

	E 90/32 PV
Reference Standards	IEC 60269-6, UL 4248-1, UL 4248-18
Rated voltage V DC	1000
Rated current A	1...30
Breaking capacity kA	10
Minimum breaking capacity	From 1 A up to 7 A = 1.35 x I _n From 8 A up to 30 A = 2.0 x I _n
Dimensions mm	10.3 x 38
Weight g	7



6.10 Remote command devices

GSM ATT

The ATT modules are GSM telephone actuators for electrical loads remote control over mobile phone network. In particular, the ATT-22 version consists of a control module with 2 outputs and 2 inputs for photovoltaic applications. Instructions and alarms can be sent via SMS message and free phone call rings. Configuration can be accomplished by SMS messages or using the ATT-Tool software. All the ATT modules are supplied with a backup battery, ATT-Tool programming software and PC connecting cable.

In addition, the ATT-22E models are equipped with a pre-wired external antenna – essential if the module is installed in locations that do not assure adequate GSM coverage.

The modules can be supplied with a modular transformer.



Main technical specifications GSM ATT

GSM module		Dual band EGSM900 and GSM1800 for data, sms, fax and voice applications. Full Type Approved conforming to ETSI GSM Phase 2+ Class 4 (2 W@900 MHz) Class 1 (1 W@1800 MHz)	
Output power		Class 4 (2 W@900 MHz) Class 1 (1 W@1800 MHz)	
Power consumption		5 VA	
Commands sent by		SMS, call rings, DTMF tones, GPRS connection	
Incoming alarms		SMS, call rings, e-mail, fax	
Inputs	digital	self-powered max. 20 VDC, 2 mA	
	analog	input voltage 0...10 V	
		input impedance < 10 KOhm / 100 nF	
Outputs	relay	NO 4 A 250 V AC- max 2500 VA	
	minimum load	100 mA, 12 V	
GSM indicator LED	OFF	device not powered	
	STEADY	device under power not connected to mobile network, SIM pin code missing or incorrect device	
	SLOW BLINK	Under power, connected to mobile network	
	FAST BLINK	communication in progress	
Power supply	V	12 ±10% c.a./c.c.	
Power consumption	when transmitting [W]	W	2,5
	in stand-by	W	0,4
Terminal section	mm ²	2,5	
Temperature	ambient	°C	-20...55
	storage	°C	-30...85
Relative humidity	ambient	5...95% non condensing	
	storage	5...95% only external condensation	
Modules	4		
Protection	IP40		
Reference standards	R&TTE, Directive 1999/5/EG; Low Voltage, Directive 2006/95/CE; EMC, Directive 2004/108/CE		

6.11 Insulation monitoring devices

ISL-A 600, ISL-C 600

In IT electrical distribution networks with isolated neutral, and in PV networks particularly, the high insulation impedance prevents earth faults from generating currents that would dangerously elevate the potential of exposed conductive parts. Therefore, in case of earth leakage, in an IT network it is not necessary to interrupt the supply, but it is still essential to monitor the insulation level in order to detect faults and restore optimal functioning of the system.

The ISL-C 600 is a insulation monitoring device for IT distribution networks up to 760 VAC (1100 VAC in three phase networks with neutral). The ISL-A 600 version is an insulation monitoring device for DC IT networks up to 600 VDC.



Main technical specifications

	ISL-A 600	ISL-C 600
Power consumption VA	6	5
ALARM threshold k Ω	-	30÷300
TRIP threshold k Ω	30÷300	10÷100
Max measuring current mA	1,5	0,240
Max measuring voltage VDC	-	48
Internal Impedance k Ω	880 k Ω L+/L- 450 k Ω L/ ground	200
TRIP relay output (NO-C-NC)	1	2
ALARM relay output (NO-C-NC)	2	-
Relay contact capacity	250 V 5 A	
Operating temperature °C	-10 ÷ 60	
Storage temperature °C	-20 ÷ 70	
Relative humidity	≤ 95%	
Max terminal section mm ²	2,5	
IP class	IP40 front, IP20 case	
Modules	6	6
Weight g	400	500
Reference standards	EN 61010-1, EN 61557-8, EN 61326-1	EN 61010-1, EN 61557-8, EN 61326-1

Insulation monitoring device CM-IWN

The CM- IWx series offers an innovative insulation monitoring device. Thanks to increased performance the CM-IWN.5 is able to provide reliable measurements in installations with a capacity of earth leakage up to 1000 μ F. In combination with a new measurement principle, networks up to 1000 VDC or 690 V AC (15-400 Hz monitor range) can be measured.

Measurement principle

Using CM-IW.x, a pulsating measurement signal is sent to the system to be monitored and the insulation resistance is calculated. This pulsating measurement signal changes depending on the insulation resistance and system dispersion capacity. The change in the insulation resistance can be forecast from this alteration. When the estimated insulation resistance corresponds to the insulation resistance calculated in the next measurement cycle and is below the pre-set value, the output relays are either activated or deactivated depending on the configuration of the device. This measurement principle is also useful to detect symmetrical insulation faults.

Main Characteristics

- Compliance with IEC/EN 61557-8 reference standards
- Direct connection to systems up to 690 V AC and 1000 VDC with coupling module CM-IVN
- Nominal frequency 15-400 Hz
- Wire interruption monitoring
- Faulty setting monitoring

- High reliability with built-in system start-up test
- Possibility to reset and test at product front or via remote control
- New predictive measurement principle
- Maximum capacity of earth leakage 1000 μ F

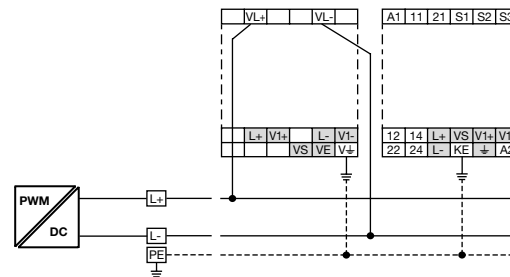

2 wires DC system

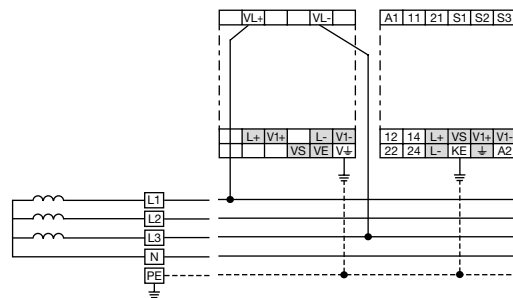

4 wires AC system

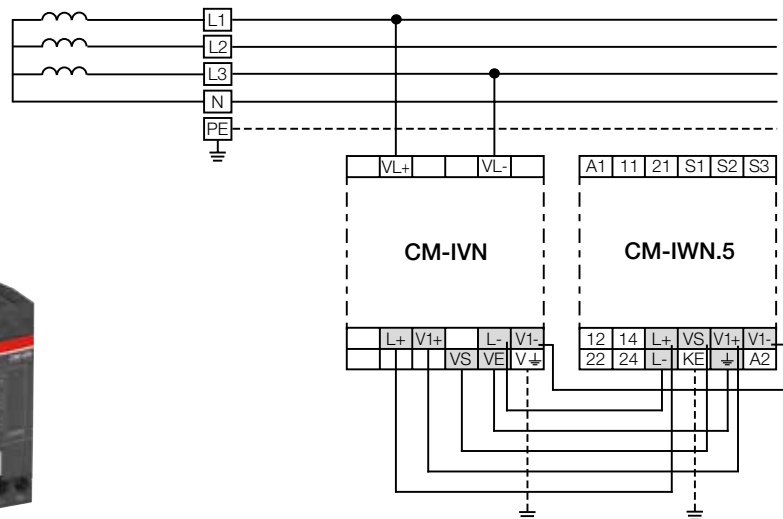

6.12 Monitoring relay - CEI 0-21 standard

CM-UFD.M22

The new protection relay (SPI) for three phase networks voltage and frequency monitoring provides the switch over of the Distributed Generation (DG) when electrical parameters exceed setup parameters.

Totally configurable, it offers the flexibility needed for integrate medium and small networks into main systems.

Main features:

- Monitoring of voltage and frequency in single- and three phase mains 2-wire, 3-wire or 4-wire AC systems
- Type tested in accordance to CEI 0-21
- Over- and undervoltage, 10 minutes average value as well s over- and underfrequency monitoring
- Two-level threshold settings for over-/undervoltage and frequency
- ROCOF (rate of change of frequency) monitoring configurable
- Integrated management of redundancy function (acc. CEI 0-21, mandatory in plants with P>20 kW)
- Measured values, thresholds and settings shown on the display
- All threshold values adjustable as absolute values
- Default setting according to CEI 0-21
- True RMS measuring principle
- High measurement accuracy
- 3 control inputs for remote trip, feedback signal, and external signal
- Tripping delay for each threshold adjustable
- Interrupted neutral detection
- Error memory for up to 99 entries (incl. cause of error, measured value, relative timestamp)
- Autotest function

- Password setting protection
- 3 c/o (SPDT) contacts
- LEDs for the indication of operational states
- Multiline, backlit LCD display

Main technical specifications	CM-UFD.M22
Supply Voltage	24-240 V CA/CC (-15, +10%)
5 seconds of buffering during auxiliary voltage faults	external (CP-B)
Power consumption	1.5 VA (1.5 W)
Over/Under-Voltage interval	(L-N) 0 -312 V CA (L-L) 0 - 540 V CA
Over/Under-Frequency interval	40-60 Hz
Voltage measurement accuracy ± 2 % of measured value	
Frequency measurement accuracy	$\pm 0,02$ Hz
Output relay	250 VAC - 5 A
Inputs	Self supplied; maximum lenght unshield cables 10 m
Dimensions	108 x 90 x 67 mm
Operating temperature	-20...+60 °C
Product Standard	IEC/EN 60255-1
Application Standards	CEI 0-21: 2012-06 + CEI 0-12; V1: 2012-12 + A70 Terna
Low Voltage Directive	2006/95/EC
EMC Directive	2004/108/EC
RoHS Directive	2011/65/EC



CM-UFD.M21 version also available, in compliance with Std. VDE-AR-N 4105.

6.13 Power buffers

CP-B range

In most areas of automation, generation and energy management, power supply systems must be highly reliable. To overcome the temporary interruptions of electricity, in-storage systems are increasingly used. The CP-B buffer modules offer an ideal solution to ensure the continuity of interface protection devices (DDI) in compliance with CEI 0-21 standard, June 2012 edition.

It is in fact necessary to ensure the auxiliary supply for at least 5 seconds even in the absence of the network, avoiding undue separations at the occurrence of voltage faults (LVFRT-Low Voltage Fault Ride Through), thus increasing the overall efficiency of the system.

The common battery systems have a limited lifetime, are affected by environmental constraints and need regular maintenance, resulting in expenditure of labor and costs.

Using the latest ultracapacitor technology, ABB offers an innovative and completely maintenance-free solution for buffering the 24 VDC up to 20 A in the event of a mains supply interruption. Thanks to the CP-B series modules, in case of power fault, the energy stored in the capacitor ensures the load continuity up to several hundreds of seconds depending on absorbed current.

Key Features

- Output voltage 24.0 VDC, 23.0 V in buffer mode
- LED for status indication
- Relay contacts for status signaling
- Backup times higher (i.e. With CP-B 24/10.0 up to 6 minutes for a load current of 1 A)
- Quick charging times
- High efficiency, exceeding 90%
- Wide operating temperature range -20...+60 ° C
- DIN rail mounting, compact enclosures
- Advantages in comparison to battery buffer modules: maintenance-free, deep discharge immunity, resistance to high temperatures
-  us Approval (UL508, CSA 22.2 Ranked # 14)¹⁾

1) In progress

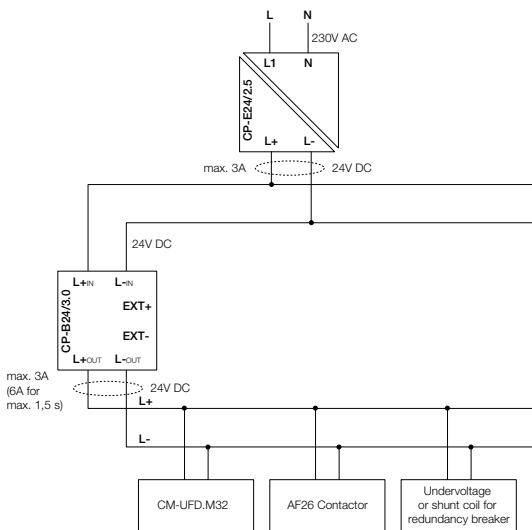

Main technical specifications		CP-B 24/3.0	CP-B 24/10.0	CP-B 24/20.0	CP-B EXT.2
ABB code		1SVR 427 060 R0300	1SVR 427 060 R1000	1SVR 427 060 R2000	1SVR 427 065 R0000
Order code		CPB243	CPB2410	CPB2420	CPBEXT2
Nominal Input Voltage DC		24 V	24 V	24 V	-
Nominal Current DC		3 A	10 A	20 A	-
Storable Energy (min.)		1000 Ws	10000 Ws	8000 Ws	2000 Ws
Typical charge time 100% with 0% load current		65 s	120 s	68 s	
		56 s	82 s	62 s	
Typical buffering time¹⁾					
According to load current	100 %	14 s	40 s	15 s	
	50 %	28 s	80 s	30 s	
	25 %	74 s	140 s	60 s	
	10 %	148 s	380 s	150 s	
Dimensions					
Length		60 mm	127 mm	84 mm	60 mm
Height		92,5 mm	163 mm	192 mm	92,5 mm
Depth		116 mm	150 mm	198 mm	116 mm

¹⁾ Buffering Time ~ $\frac{\text{storable energy} * 0.9}{23 \text{ V}}$

6.14 Modular energy meters

EQ meters

Modular energy meters are ideal for metering and monitoring the energy produced by a photovoltaic system downstream of the inverter. ABB EQ meters are compliant and tested according to the European MID directive, which allows meters to be used whenever an energy consumption reading is requested for billing.

The EQ meters are available in three different product ranges, A, B and C series.

A series:

- Single phase or three phase
- Direct connected up to 80 A or transformer current- and/or voltage transformers (CTVT)
- Active energy measurement Class B (Cl. 1) or Class C (Cl. 0,5 S) on CTVT connected meters
- Wide voltage range 100 - 500 V phase to phase 57,7 - 288 V phase to neutral
- Alarm function
- MID
- Reactive energy measurement
- Import/export measurement of energy
- Optional communication via M-Bus or RS-485
- 4 tariffs controlled by inputs, communication or built-in clock

- Previous values (by day, week or month)
- Demand measurement (max and min)
- Load profiles (8 channels)
- Harmonics measurement up to 16th harmonic and evaluation of THD

B series:

- Single phase or three phase
- Direct connected up to 65 A or CT connected (three phase versions)
- Active energy measurement Class B (Cl. 1) or Class C (Cl. 0,5 S)
- Alarm function
- MID
- Reactive energy measurement
- Import/export measurement of energy
- Optional communication via M-Bus or RS-485
- 4 tariffs controlled by input or communication

C series:

- Single phase or three phase
- Very compact, 1 & 3 modules
- Direct connected up to 40 A
- Active energy measurement
- Instrument values
- Accuracy class 1 or class B (MID versions)
- Alarm function
- Optional MID



Standards

IEC 62052-11, IEC 62053-21 class 1 & 2, IEC 62053-22 class 0,5 S, IEC 62053-23 class 2, IEC 62054-21, EN 50470-1, EN 50470-3 category A, B & C.

Communication

Built-in communication interfaces and separate communication devices enable serial data communication between energy meter and remote supervision system. Data on energy consumption and electrical parameters to be collected via serial protocols such as: Modbus RTU, M-Bus, Ethernet TCP/IP and KNX.

CT current transformers

Whenever indirect measurement is required, CT current transformers are the best solution to create a complete plant, ensuring long-term accuracy and precision of measurements.

Serial Communication Adapters

Communication adapters allow the serial data communication between energy meter and remote supervision system. The adapters allow data on energy consumption and electrical parameters to be collected via serial protocols such as: Modbus RTU, MeterBus, Ethernet TCP/IP, KNX.

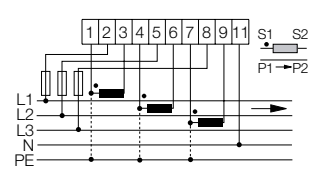

Three-phase system with neutral

DAB13000

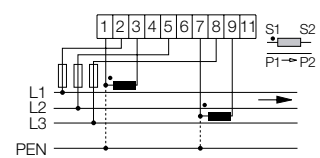

Three-phase system without neutral

DAB12000

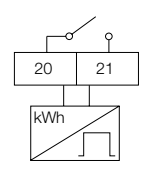

Pulse output active energy meters



6.15 Switchboards

Gemini IP 66

Main technical specifications

Protection		Gemini IP 66
Protection class	IP 66 (CEI EN 60529)	
Insulation		class II
Strength		
Material	joint-injection moulded thermo-plastic	
Heat and fire resistance		up to 750 °C (IEC EN 60695-2-11)
Shock resistance		IK10 (IEC EN 50102)
Protection against chemicals and weather conditions	water, saline solutions, acids, basics, mineral oils, UV rays	
Operating temperature		-25 °C...+100 °C
Performance		
Nominal insulation voltage	1000 V AC – 1500 VDC	
Flexibility WxHxD, external dimensions	6 sizes from 335 x 400 x 210 mm to 840 x 1005 x 360 mm DIN modules from 24 to 216	
Installation	Snap-in assembly of all components	
Standards, quality, environment	IEC EN 50298, IEC 23-48, IEC 23-49, IEC 60670, IEC EN 60439-1 IMQ Mark according to the IEC EN 50298 standard. Fully recyclable	



6.16 Wall mounting consumer units

Europa series

The Europa series wall-mounting units feature IP65 protection which makes them ideal for outdoor installation. This means that they can be used for making string boxes on the load side of photovoltaic strings.

The main features of the Europa series wall-mounted units include:

- class II insulation
- manufactured in self-extinguishing thermoplastic material able to withstand abnormal heat and fire up to 650 °C (glow wire test) in compliance with IEC 60695-2-11 standards
- installation temperature: -25 °C to +60 °C
- nominal insulation voltage: 1000 V AC; 1500 VDC
- shock resistance: 6 joules (IK 08 degrees)
- pull-out DIN rails holder frame for more convenient bench wiring can be disassembled (and re-assembled by means of a snap-fit mechanism) to make the individual wires easier to route
- 53, 68 and 75 mm depth switchgear can be installed
- models with 8 or more modules equipped with bi-metal and rigid flanges for easier insertion of pipes and cables
- consumer units in compliance with IEC 23-48, IEC 23-49 and IEC 60670 standards
- IMQ approved



6.17 Junction boxes

ABB provides IP65 polycarbonate junction boxes that are perfect for use in outdoor installations.

The main features of the junction boxes include:

- class II insulation
- manufactured in self-extinguishing thermoplastic material able to withstand abnormal heat and fire up to 960 °C (glow wire test) in compliance with IEC 60695-2-11 standards
- installation temperature: -25 °C to +60 °C
- nominal insulation voltage: 1000 V AC; 1500 VDC
- shock resistance: 20 joules (IK 10 degrees)
- junction boxes in compliance with IEC 23-48 and IEC 60670 standards
- IMQ approved



Description Type	Dimensions
Box IP65 PC	140x220x140
Box IP65 PC	205x220x140
Box IP65 PC	275x220x140

6.18 Cable glands and nuts with metric pitch

Main technical features of the cable glands and nuts with metric pitch:

- IP 68 protection class
- material: polyamide 6.6, self-extinguishing material in accordance with the UL94 V2 standard, withstands abnormal heat and fire up to 750 °C (glow wire test) according to IEC 60695-2-11 standards
- utilization temperature: from -20 °C to +120 °C (brief period)
- neoprene seal
- tightening by means of a lamellar crown around the entire cable diameter
- possibility of reuse of the gland without compromising its effectiveness



6.19 Screw clamp terminal blocks

The screw clamp terminal blocks of the new SNK series are ideal for use in photovoltaic systems.

The SNK series offers a modern, innovative and compact design, and a wide range of accessories for any requirement. The series come with the highest international certifications.

Main technical specifications

Electrical characteristics	
Nominal voltage V	1000
Nominal current A	max 232
Nominal section mm ²	max 95

Compliance with IEC 60947-7-1, IEC 60947-7-2 standards
 Parallel interconnections are available
 Self-extinguishing material UL94V0



The screw clamp terminal blocks are available in single pole, 3-pole and 4-pole versions.

Main technical specifications

Electrical characteristics	
Nominal voltage	1000 V AC / 1500 V DC
Nominal current	max 400 A for single pole max 175 A for 3-pole 125 A for 4-pole



6.20 Polyamide 6.6 and 12 cable ties - UV resistant black

The main features of the cable ties include:

- UV-resistant version, especially recommended for outdoor applications
- Black version (2% carbon for military specifications)
- Also available in heat stabilized + UV-resistant version, for outdoor applications that also require a resistance to high temperature (+105 °C). See page 21 (TY...MX-A series)
- Several lengths and 6 typical widths with a tensile strength up to 780N, to cover the most demanding applications
- Packaging: OEM bulk quantities in recyclable polythene bags
- Also available in small bags with Euroslot and in work-bench boxes



Main technical specifications

Material - Moulding	polyamide 6.6 and polyamide 12
Material - Locking barb	316 grade stainless steel
Temperature range	-40°C to +85°C
Colour	black
Flammability rating	UL 94 V-2
Other properties	UV-resistant, Halogen free, Silicone free



6.21 PMA Cable Protection System Solutions

PMA offers a broad product portfolio of cable protection products.

Our 30 years experience in the design and production of cable protection systems guarantees optimal solutions for use in power generation applications whether they are driven by water, wind, sunlight or gas.

- Protection degree: IP66 / IP68 and IP69K
- Metric, NPT and PG threads made of metal and plastic
- Available with strain relief elements



- Compatible with all leading component manufacturers
- EMC fittings in the standard range
- Junction pieces available from stock
- Continuous operating temperature: -100 °C to +200 °C
- Both for internal and external use
- Excellent UV resistance
- Resistant to high dynamic loading
- Extremely high compression strength
- Electro-statically discharging materials
- Nominal diameters: 07 to 125
- Closed and divisible conduits types
- Free from halogens, REACH + ROHS compliant



6.22 Direct lightning protection

OPR, simple rod & earthing system

To provide efficient protection for a Solar system, the PV plant must be protected against direct lightning strikes and have a proper grounding system in addition to protection against overvoltage on both side of the inverter. ABB offers:

- OPR, ESE lightning rod protect against direct lightning,
- simple rod lightning protection against direct lightning,
- earthing and interconnection system to safely dissipate the lightning current.

Main technical specifications

	OPR
Lightning current withstand (10/350µs) kA	100
Gain in Sparkover Time µs	30 / 60
EMC Interferences measurement	
Interferences immunity	EN 50 081.1 / EN 50 082.2 / NFC17102



6.23 Switchboards for string control and monitoring system for large networks

Designed for large systems, but also for commercial applications, the string control switchboards allow to maintain the control of each string and to report any loss in energy production. Depending on the number of strings to check, the switchboards are equipped with all the devices needed for the protection and the disconnection of the string, as well as with AC500 PLC series of components.



- 12 strings - 1000V**
Gemini switchboard size 5 IP66
Dimensions: 590 x 855 x 360
- 16 strings - 1000V**
Gemini switchboard size 6 IP66
Dimensions: 840 x 1005 x 360
- 24 strings - 1000V**
Gemini switchboard size 6 IP54
Dimensions: 840 x 1005 x 360

Dimensions: b x h x p mm

Using a RS485 serial line, they transmit to a substation PLC the current values, and the status of switches and surge arresters of the individual strings. This allows assessing the productivity of the plant via software.



Substation PLC - AC500 series*
Dimensions: 590 x 700 x 260

Datalogger
Solar Datalogger for substation concentrator switchboard

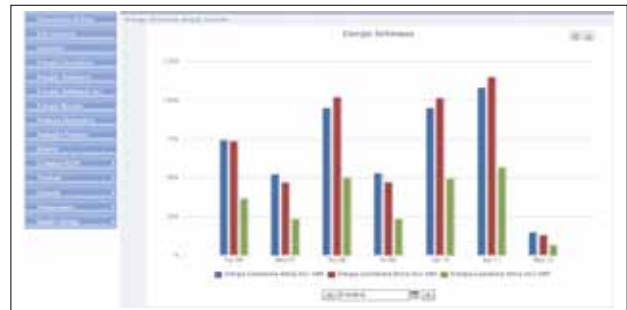

6.24 Pre-wired interface switchboards

In addition to the interface protection relay, the Italian CEI 0-21 Standard* provides the requirements for other components needed to produce an interface switchboard. The main components provided by ABB for this kind of applications are:

- S 200 series main switches or E 90 fuse holders
- OS disconnectors with fuse holder
- interface protection relay CM-UFD.M22
- Class AC-3 omnipolar contactor (series AF or EK) coordinated with suitable protection for short circuit protection or Tmax series moulded-case circuit-breakers with undervoltage release and motor for reset
- energy storage system for CM-UFD.22 relay and for contactors or circuit breakers: CP-E 24 series and buffer modules CP-B series
- Gemini series switchboards
- SNK Series terminal blocks
- E 90 fuse holders

For power installations over 20 kW, an undervoltage or shunt trip device is required to manage a remote external switch.

* CM-UFD.M21 version also available, in compliance with Std. VDE-AR-N 4105.

Main technical specifications

Pre-wired interface switchboards	Power	Gemini Size
Pre-wired interface switchboards	6 kW	Size 1
Single phase Pmax 6 kW		
Pre-wired interface switchboards	13,5 kW	Size 2
Three phases 3P+N Pmax 13,5 kW		
Pre-wired interface switchboards	20 kW	Size 2
Three phases 3P+N Pmax 20 kW		
Pre-wired interface switchboards	31 kW	Size 3
Three phases 3P+N Pmax 31 kW		
Pre-wired interface switchboards	46,5 kW	Size 5
Three phases 3P+N 46,5 kW		



6.25 DC string boxes

ABB catalog of photovoltaic systems is complemented by a wide range of PV array combiner boxes, string switchboards and parallel switchboards ready to install. These products, based on insulation class II units, are equipped with all the necessary components to realize the functions of protection and isolation, according to the type of system.



1 string
Europa consumer units
IP65 8 modules
10 A, 800 V
 Miniature circuit breaker
S802PV-S10
 Surge arrester
OVR PV 40 1000 P TS

Europa consumer units
IP65 12 modules
16 A, 660 V
 Switch-disconnector
OTDC 16 F2
 Surge arrester
OVR PV 40 1000 P TS
 Disconnecting fuses
E 92/32 PV

16 A, 1000 V
 Switch-disconnector
OTDC 16 F3
 Surge arrester
OVR PV 40 1000 P TS
 Disconnecting fuses
E 92/32 PV



2 strings
Europa consumer units
IP65 12 modules 1
6 A, 800 V
 Miniature circuit-breaker
S802PV-S16
 Surge arrester
OVR PV 40 1000 P TS

Europa consumer units
IP65 18 modules
25 A, 660 V
 Switch-disconnector
OTDC 25 F2
 Surge arrester
OVR PV 40 1000 P TS
 Disconnecting fuses
E 92/32 PV for each string

25 A, 1000 V
 Switch-disconnector
OTDC 25 F3
 Surge arrester
OVR PV 40 1000 P TS
 Disconnecting fuses
E 92/32 PV for each string



3 strings
Europa consumer units
IP65 18 modules
32 A, 660 V
 Switch-disconnector
OTDC 32 F2
 Surge arrester
OVR PV 40 1000 P TS
 Disconnecting fuses
E 92/32 PV for each string

32 A, 800 V
 Miniature circuit-breaker
S802PV-S32
 Surge arrester
OVR PV 40 1000 P TS
 Disconnecting fuses
E 92/32 PV for each string

32 A, 1000 V
 Switch-disconnector
OTDC 32 F3
 Surge arrester
OVR PV 40 1000 P TS
 Disconnecting fuses
E 92/32 PV for each string



4 strings Europa consumer units
IP65 36 modules
32 A, 660 V
 Switch-disconnector
OTDC 32 F2
 Surge arrester
OVR PV 40 1000 P TS
 Disconnecting fuses
E 92/32 PV for each string

32 A, 1000 V
 Switch-disconnector
OTDC 32 F3
 Surge arrester
OVR PV 40 1000 P TS
 Disconnecting fuses
E 92/32 PV for each string

40 A, 800 V
 Miniature circuit-breaker
S802PV-S40
 Surge arrester
OVR PV 40 1000 P TS
 Disconnecting fuses
E 92/32 PV for each string



5 strings
Gemini switchboard size 1 IP66
50 A, 800 V
 Miniature circuit breaker
S802PV-S50
 Surge arrester
OVR PV 40 1000 P TS
 Disconnecting fuses
E 92/32 PV for each string

50 A, 800 V
 Switch-disconnector
T1D 160 PV
 Surge arrester
OVR PV 40 1000 P TS
 Disconnecting fuses
E 92/32 PV for each string



6 strings
Gemini switchboard size 2 IP66
63 A, 800 V
 Miniature circuit-breaker
S802PV-S63
 Surge arrester
OVR PV 40 1000 P TS
 Disconnecting fuses
E 92/32 PV for each string

63 A, 800 V
 Switch-disconnector
T1D 160 PV
 Surge arrester
OVR PV 40 1000 P TS
 Disconnecting fuses
E 92/32 PV for each string

8 strings
80 A, 1000 V
 Miniature circuit-breaker
S804PV-S80
 Surge arrester
OVR PV 40 1000 P TS
 Disconnecting fuses
E 92/32 PV for each string

80 A, 1000 V
 Switch-disconnector
T1D 160 PV
 Surge arrester
OVR PV 40 1000 P
 Disconnecting fuses
E 92/32 PV for each string



10 strings
Gemini switchboard size 4 IP66
100 A, 1000 V
 Switch-disconnector
T1D 160 PV
 Surge arrester
OVR PV 40 1000 P TS
 Disconnecting fuses
E 92/32 PV for each string

12 strings
120 A, 1000 V
 Switch-disconnector
T1D 160 PV
 Surge arrester
OVR PV 40 1000 P TS
 Disconnecting fuses
E 92/32 PV for each string



14 strings
Gemini switchboard size 4 IP66
140 A, 1000 V
 Switch-disconnector
T1D 160 PV
 Surge arrester
OVR PV 40 1000 P TS
 Disconnecting fuses
E 92/32 PV for each string

16 strings
160 A, 1000 V
 Switch-disconnector
T1D 160 PV
 Surge arrester
OVR PV 40 1000 P TS
 Disconnecting fuses
E 92/32 PV for each string

6.26 CPI DC string boxes

The CPI versions of ABB DC string switchboards are based on M-series S800PV or Tmax PV load switch-disconnectors, with undervoltage release. The connection with an emergency switchboard, to be installed in a visible and accessible site, allows a simple and fast disconnection of the line between the DC switchboard and the inverter, thus ensuring a high standard of safety for example when an emergency intervention by firefighters is needed.



1 string
Europa consumer units
IP65 12 modules
10 A, 800 V
 Switch-disconnectors
S802 PV-M32
 Equipped with:
 Undervoltage release
 Surge arrester
 Fuse disconnectors
 Screw terminals for voltages up to 1000 V
 Quick connectors MC4
 Package includes emergency switchboard (cod. 13180) and signs



2 strings
Europa consumer units
IP65 18 modules
20 A, 800 V
 Switch-disconnectors
S802 PV-M32
 Equipped with:
 Undervoltage release
 Surge arrester
 Fuse disconnectors
 Screw terminals for voltages up to 1000 V
 Quick connectors MC4
 Package includes emergency switchboard (cod. 13180) and signs



3 strings
Europa consumer units
IP65 36 modules
30 A, 800 V
 Switch-disconnectors
S802 PV-M32
 Equipped with:
 Undervoltage release
 Surge arrester
 Fuse disconnectors
 Screw terminals for voltages up to 1000 V
 Quick connectors MC4
 Package includes emergency switchboard (cod. 13180) and signs



5 strings
Gemini Switchboard Size 2
IP66 54 modules
50 A, 1000 V
 Switch-disconnector
Tmax T1D160 PV
 Equipped with:
 Undervoltage release
 Surge arrester
 Fuse disconnectors
 Screw terminals for voltages up to 1000 V
 Quick connectors MC4
 Package includes signs



6 strings
Gemini Switchboard Size 2
IP66 54 modules
60 A, 1000 V
 Switch-disconnector
Tmax T1D160 PV
 Equipped with:
 Undervoltage release
 Surge arrester
 Fuse disconnectors
 Screw terminals for voltages up to 1000 V
 Quick connectors MC4
 Package includes signs



4 strings
Europa consumer units
IP65 36 modules
40 A, 800 V
 Switch-disconnectors
S802 PV-M63
 Equipped with:
 Undervoltage release
 Surge arrester
 Fuse disconnectors
 Screw terminals for voltages up to 1000 V
 Quick connectors MC4
 Package includes emergency switchboard (cod. 13180) and signs

8 strings
80 A, 1000 V
 Switch-disconnector
Tmax T1D160 PV
 Equipped with:
 Undervoltage release
 Surge arrester
 Fuse disconnectors
 Screw terminals for voltages up to 1000 V
 Quick connectors MC4
 Package signs

S800-FSS Fire Service Switch

According to VDE-AR-E 2100-712

Designed for large systems, but also for residential applications. The Fire Service Switch will provide optimal protection for persons and objects.

Depending on the number of inverter MPPT's, two version are available. All fault contingencies are covered with this protection system. Through an innovative remote switch after fault clearing or power outage the system will switch on automatically.

Short voltage interruptions or voltage fluctuations will be detected and the system won't trip.

Maximum protection in case of fire combined with highest reliability is given with the new Fire Service Switch.

Key Features

- Disconnection properties, switching under load
- String protection up to 63A
- Operation with a button or optional with smoke detector
- Contact status visualization
- Closed circuit current principle
- Remote switch, after fault clearing or power outage the system will switch on automatically
- Short voltage interruptions or voltage fluctuations will be bridged through an energy storage.
- Intuitive operation

Fields of application

- PV systems on roofs of industrial, public and farm buildings
- PV systems on roofs of residential buildings
- PV systems on front of buildings

Main technical specifications

	S810 - FSS	S820 - FSS
Channels	1	2
System Voltage	1200V	1000V
Max Current	63A	2 x 32A
Aux Contacts	1 NC + 1 NO	1 NC + 1 NO
Energy Storage	4 sec.	4 sec.
Dimensions	335 x 400 x 210	335 x 400 x 210
IP	IP 65	IP 65



6.27 Multi-output DC string boxes

The multi-output DC switchboard contains independent circuits in a single switchboard allowing the autonomous management of the individual strings from the inverter (multi MPPT) and ensuring the maximum performance of the system.



2 strings (2 inputs, 2 outputs)

Europa consumer units

IP65 36 modules

16 A, 660 V

Switch-disconnector

OTDC 16 F2

Surge arrester

Fuse disconnectors

Screw terminals for voltages up to 1000 V

10 A, 800 V

Miniature circuit-breaker

S802 PV-S10

Surge arrester

Fuse disconnectors

Screw terminals for voltages up to 1000 V



3 strings (3 inputs, 3 outputs)

Gemini Switchboard size 2

IP66 54 modules

16 A, 1000 V

Switch-disconnector

OTDC 25 F3

Surge arrester

Fuse disconnectors

Screw terminals for voltages up to 1000 V

10 A, 1000 V

Miniature circuit-breaker

S804 PV-S10

Surge arrester

Fuse disconnectors

Screw terminals for voltages up to 1000 V

Annex A: New technologies

A.1 Cells: emerging technologies

New different technologies are being the subject of research and development activities. These emerging technologies can be divided into two typologies according to their inspiring concept:

- low cost type, which includes “dye sensitized” cells, organic cells and hybrid cells based on inorganic-organic nanocompounds (DSSC);
- high efficiency type, which involves different approaches to get some cells which can exceed the theoretical limit of solar conversion efficiency for a single junction, that is 31% without concentration and 40.8% at the maximum possible concentration (OSC).

Dye sensitized solar cells (DSSC – also known as Grätzel cells from the name of their inventor) consist of a glass or plastic sub-layer with the following elements deposited one upon the other: a thin film conductive transparent electrode, a porous nanocrystal layer of the semiconductive titanium dioxide (TiO_2), dye molecules (metal-organic complexes of ruthenium) distributed on the TiO_2 surface, an electrolyte formed by an organic solvent and a redox pair as iodide/trioxide and a platinum-catalyzed counter electrode. Unlike traditional cells, the function of sunlight absorption and generation of electric charges is separated from the transportation function of charges. In fact, the dye molecules absorb light and create the electron-hole pairs, the electrons are injected into TiO_2 and transported up to the contact area, the redox pair provides the dye with the yielded electron by closing the internal circuit with the rear electrode (where the electrons from the external circuits are drawn).

The main advantage of such technology is represented by the possibility of depositing the different materials on a large area by low-cost processes; in fact, production costs are expected to reach about 0.5 €/W.

The efficiency of this cell technology has reached interesting levels and is continuing to grow: the efficiency for commercial applications is 10%, but in laboratories 12.3% has been achieved.

Besides, DSSC cells function also when lighting is reduced since they are not subject to recombination losses, which are a remarkable phenomenon under poor irradiance conditions (e.g. cloudy sky).

The minimum irradiance level they require to favor the operation is lower than required by traditional silicon cells and therefore their use has been recommended also for internal applications, collecting energy from the lighting plants

Organic solar cells (OSC) consist of a conductive transparent electrode (ITO on glass or plastic), an active material constituted by organic molecules or polymers and a

metallic counter-electrode. In the OSC the absorption of the sunlight and the liberation of electric charges occur through the organic material which is responsible also for transporting the charges generated by PV effect to the electrodes.

The most efficient organic cells (but they reach only some percentage point) are inspired by the chlorophyll photosynthesis process: they use a mixture of compounds such as vegetal pigments, e.g. the anthocyanins derived from the fruits of the forest, or the polymers and the molecules synthesized in order to maximize the absorption of solar radiation.

In the *hybrid cells* the active material can be a mixture of organic molecules and of nanoparticles of inorganic compounds (e.g. carbon nanotubes).

Organic semiconductors have the capabilities necessary to reach in the medium-long term the aim of producing PV panels at low cost, since they can be synthesized and then deposited, at low temperature and with a low industrial cost, on a large area also on flexible sub-layers. For the time being, the main limit of this typology is its conversion efficiency (<7%). Moreover, further studies on the stability and life time of these devices should be carried out.

The activities in progress for high efficiency are aimed above all at producing multiple devices positioned in series, in which each of the junctions is designed and realized with a specific material for photogeneration in a specific interval of the solar radiation spectrum.

Since each single junction needs a different energy to determine the transfer of the electrons from the valence band to the conduction band, it is possible to use the energy of a greater number of photons than solar radiation, with conversion efficiency higher than 30% (theoretical limit 50%).

Among the most promising solutions there is the realization of quantum dot (QD) silicon based cells. In this case, the photoactive material consists of silicon nanocrystals with nearly spherical form and diameter smaller than 7 nm, embedded in a matrix of silicon-based dielectric material, such as silicon oxide, silicon nitride or silicon carbide.

By controlling the dimensions and density of the dots it is possible to provide the material with the most suitable characteristics to exploit part of the solar spectrum.

A material suitable for photovoltaics shall consist of a more or less regular lattice of silicon quantum dots, with diameter of some nm and positioned at about 1 nm distance in a silicon nitride or carbide matrix.

An alternative approach for high efficiency is using concentration systems able to separate, through dichroic materials, the different chromatic components of the incident solar radiation, sending them to different physi-

cally separated cells, each able to exploit at the best a part of the solar spectrum. This approach avoids the use of the expensive multijunction cells and reduces the problem of the temperature rise of the PV cells present in the traditional concentration systems.

At present, the modules based on such technologies are not available on the market even if the first pilot production lines are being set up. The estimated time to have organic cells with commercial diffusion is around ten years.

Figure A.1 shows the forecast of the market share for these technologies considered in the short, medium and long time. The new concepts include, in addition to the emerging technologies, also concentrated photovoltaics.

Figure A.1

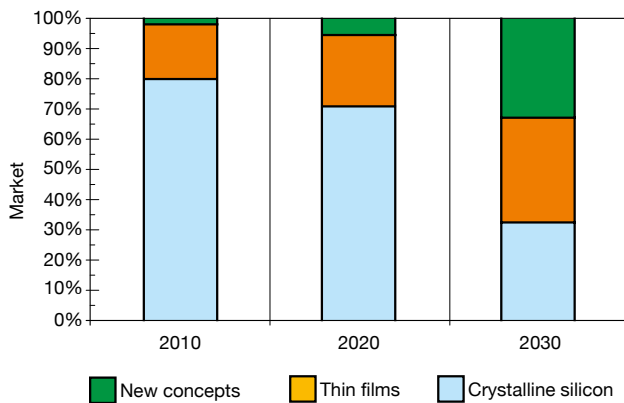

A.2 Concentrating photovoltaics

Concentrating solar plants exploit the principle of solar radiation concentration by means of suitable optical systems to strike directly the PV cells with the light. The concentrators currently used are both refractive (Fresnel or prismatic lens) as in the “Point-focus” solutions (in which each cell has a dedicated focus), as well as reflective in the “Dense array” solutions (in which there is a single optical focus for an assembly of cells positioned along the line where the solar radiation concentrates). Keeping constant the peak power of the system, the semiconductor area used is reduced by a factor equal to the optical concentration and therefore there is an increase in the PV conversion efficiency in comparison with traditional technologies.

However, concentrating photovoltaics implies more complex plant design and engineering due to:

- the necessity of installing the plants in areas with high direct solar radiation, which makes the analysis of the characteristics of the location quite difficult in the design phase and reduces the number of the areas suitable for such plants;
- the necessity of an accurate tracking system to keep the module as perpendicular as possible to direct solar radiation;
- the necessity of a cooling system for the cells because of the high temperature they can reach due to the increased irradiance; the operating temperature must be kept lower than 200-250°C through air-cooling systems (plate fin heat exchangers) or liquid cooling systems (with micro-tubes and possibility of using the heat taken for co-generation).

Concentration plants can be divided into:

- *low concentration plants* (2x-3x), based on rather simple reflecting systems consisting of aluminum panels positioned on both sides of a traditional PV module (Figure A.2); they have been studied in the recent past to cope with the shortage of PV modules on the market, but nowadays they are practically no more used or limited to niche installations, such as floating PV systems (see section A.4);
- *average concentration plants* (10x-200x), using single-crystalline silicon or thin film cells, often in combination with a tracking system with one degree of freedom and parabolic mirror concentrators (Figure A.3);
- *high concentration plants* (400x-1000x), using multi-junction high efficiency (in some cases higher than 40%) cells, point-focus optical instruments and a tracking system with two degrees of freedom (Figure A.4).

Figure A.2



Figure A.3



Figure A.4



In the field of distributed generation through concentrated PV systems, there is the possibility to add, to the electric power production, the recovery of the heat necessary for cogenerative applications, as mentioned above, since the heat due to the cooling of cells becomes available to be used for air-conditioning or hot sanitary water.

However, the cogenerative solution has the drawback of having the cells work at a higher temperature for heat production, which causes a reduction in the PV efficiency. Concentrating photovoltaics is still under study even if, over the last years, a gradual passage to the industrial production phase has been noticed.

The realization cost of a high concentration system with biaxial tracking has reached 3-3.5 €/W; however, PV concentrating systems still have a wide margin of improvement, not only from the point of view of manufacturing costs, but also considering the performances which can be obtained above all in terms of increase in the efficiency of the cell and of accuracy of the tracking systems.

A.3 PV systems with cylindrical modules

These semi-integrated solar power plants use cylindrical modules coated at 360° with thin films to exploit solar radiation all day long as well as the light reflected by the surface on which they lie (Figure A.5).

The cylindrical modules work in the optimum way when they are horizontally mounted one next to the other; the system is light and, unlike that using traditional modules, it is not subject to the “sail effect” and thus it does not need that modules are fixed by means of ballasted weights.

Figure A.5

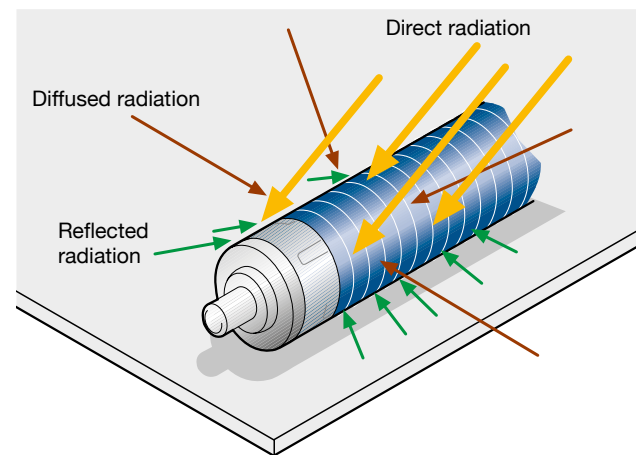

A.4 Floating PV systems

An interesting application is the floating PV plants deployed on closed waters such as high altitude reservoirs or ponds (Figure A.6). Such plants are to be installed on a floating structure of naval derivation; this structure can be equipped with hydraulic pumps (for water cooling of modules) and tracking systems. Moreover, some concentration systems may be present in order to increase the incident radiation on the cells.

The main benefits of this application are:

- limited environmental visual impact, since the water mirrors where these plants are realized are often in areas with no landscape bonds;
- water-cooling effect on the modules: a subtle water layer circulating over the panel surface keeps the module temperature at values such as to guarantee the maximum efficiency. This increases the annual energy production by about 10%, which exceeds the consumption of the pump guaranteeing cooling;

- tracking, since the floating platform can operate as a solar tracker with one degree of freedom, that is moving in the East-West direction over the day, thus ensuring an increase in the annual producibility up to 25%.

Nonetheless, there are some disadvantages which still make the use of floating systems difficult:

- still unknown the effects, over long periods, of the constant flow of the water on the modules and of their interaction with the aquatic vegetation and wildlife;
- extra-costs (about 0.8 €/W) due to the floating structure and to the tracking and cooling systems: about 50% increase in the total cost if compared with one installation of the same size on a roof or on the ground.

Figure A.6

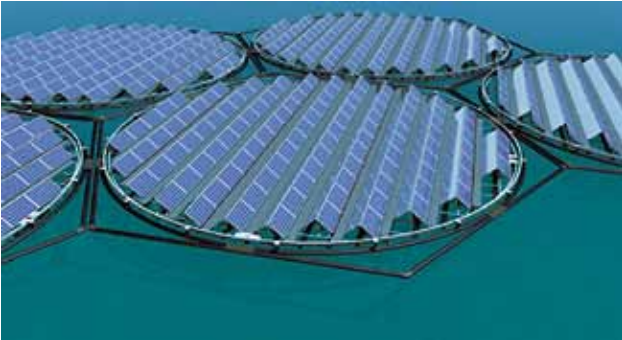

A.5 Micro-inverters

They are small-size machines (180W to 320W) which are installed on each single module and which allow some significant advantages to be obtained, such as:

- increase in the reliability of the inverter that, managing a power much lower than the traditional systems, does not need cooling systems which are often more subject to faults; thus, the annual likelihood of fault for a single micro-inverter can be up to a 40 times lower than a traditional inverter;
- increase in the producibility of the plant since every micro-inverter equipped with its own MPPT system works according to its own maximum power point, independently of the operation conditions of the other modules as it occurs, on the contrary, in the plants with central inverter; such benefit for producibility is remarkable when the modules are subject to different irradiance values for different inclinations or shading, which is a situation frequently occurring in residential installations.

On the other hand, the use of these machines present some disadvantages, such as:

- higher costs due to both the relative immaturity of this technology as well as to the impossibility of exploiting savings deriving from the purchase of large-size inverters;
- maximum efficiency of the micro-inverter 3-4% less than that of the traditional inverters due to their small-size; as a consequence, the use of micro-inverters is favorable, as already said above, only in those installations where it is impossible to have, for the most part of the annual operation hours, an irradiance condition next to the rated one because of the different inclination of the modules and because of shading.

Annex B: Other renewable energy sources

B.1 Introduction

Renewable energies are those forms of energy generated by sources which due to their intrinsic characteristic are regenerated or are not “exhaustible” in a “human” time scale and whose use does not jeopardize the natural resources for the future generations.

As a consequence, the sun, the sea, the Earth’s heat are usually considered as “renewable power sources”, that is sources whose present use does not jeopardize their availability in the future; on the contrary, the “non renewable” ones are limited for the future, both since they have long formation periods, higher than those of effective consumption (in particular, fossil fuels such as petroleum, coal, natural gas), and since they are present in reserves which are not inexhaustible on a human time scale.

If the strict definition of “renewable energy” is the above mentioned one, also the expressions “sustainable energy” and “alternative energy sources” are often used as a synonym. Yet, there are slight differences; as a matter of fact, sustainable energy is a method of production and use of energy ensuring a sustainable development, thus including also the aspect of efficiency of energy uses. Instead, alternative energy sources are all the sources different from hydrocarbons, that is deriving from non fossil materials.

Therefore, there is not an unequivocal definition of the whole of renewable sources, since in different circles there are different opinions as regards the inclusion of one or more sources in the group of the “renewable” ones.

B.2 Wind power

Wind energy is the product of the conversion of the kinetic energy of wind into other energy forms, mainly into electric energy.

The devices suitable for this type of transformation are called aerogenerators or wind turbines.

A wind turbine requires a minimum wind velocity (cut-in) of 3-5 m/s and deliver the nameplate capacity at a wind velocity of 12-14 m/s.

At high speeds the generator is blocked by the braking system for safety reasons.

The block can be carried out by means of real brakes which slow down the rotor or with methods based on the stall phenomenon, “hiding” the blades from the wind. There are also wind turbines with variable pitch blades which adjust to the wind direction, thus keeping constant the power output.

The revolutions per minute (RPM) of the wind turbine are very variable since the wind speed is variable; however, since the network frequency must be constant, the rotors

are connected to inverters for the control of the voltage and frequency at which the energy is put into the network. Kinematics of the wind generator is characterized by low frictions and with them by low overheating, therefore no refrigeration system (oil and water) is needed with a remarkable reduction in the maintenance cost.

The environmental impact has always been an important deterrent to the installation of these plants. In fact, in most cases, the windiest places are the peaks and the slopes of the mountain relieves, where wind-powered plants are visible also from a great distance, with a landscape impact which is not always tolerable.

Another problem, which is quite important when considering large scale production, is the intermittency of the generated electric power.

As a matter of fact, the wind, similarly to the sun and contrary to the conventional power sources, does not deliver power in a homogeneous and continuative way and, in particular, it cannot be controlled to adapt the produced power to the load requirements. Moreover, the authorities charged with the control of the air traffic in some countries have recently raised doubts about the installation of new wind plants since these could interfere with radars, which cannot easily eliminate the echoes due to the wind towers because of their high RCS (*Radar Cross Section*)¹.

In spite of all these constraints, in many European countries the spreading of wind parks is increasing just thanks to their ease of installation and reduced maintenance, and to the possibility of exploiting not only the mainland, but also the open sea, with the so-called offshore plants.

B.3 Biomass energy source

Biomass usable for energy production purposes consists of all those living materials which can be used directly as fuels or transformed into liquid or gaseous fuels, in the conversion plants, for a more convenient and wider usage. The term biomass includes heterogeneous materials, from the forest residues to the wastes of the wood transformation industry or of the zootechnical farms. Generally speaking all the organic materials deriving from photosynthetic reactions may be defined as biomass. In Italy biomasses cover about the 2.5% of the energy demand, with a carbon dioxide contribution to the atmosphere which can be virtually considered as null since the quantity of CO₂ released during combustion is equivalent

¹ *Radar Cross Section (RCS) is a measure of how detectable an object is with a radar, since when radar waves are beamed at a target, only a certain amount are reflected back. A number of different factors determine how much electromagnetic energy returns to the source, such as the angles created by surface plane intersections. For example, a stealth aircraft (which is designed to be undetectable) will have design features that give it a low RCS, as opposed to a passenger airliner that will have a high RCS.*

to that absorbed by trees during their growth process. Biomasses can be used in thermal generation plants with different dimensions, dimensions strictly connected to the characteristics of the territory and to the availability of this fuel in neighbouring zones.

B.4 Geothermal power

Geothermal power is a form of energy using the heat sources in the most inner areas of the earth, the subsoil. It is naturally linked to those regions where geothermal phenomena are present (in Italy Tuscany, Latium, Sardinia, Sicily and other areas in Veneto, Emilia Romagna and Lombardy can be pointed out as “hot areas”), where the heat spreading to the rocks next to the surface can be exploited to generate electricity through steam turbines, or used for heating in residential and industrial applications².

There are also technologies (geothermal sensor heat pumps) able to exploit the latent energy stored in the soil: in this case we speak of low temperature geothermal energy. These pumps are electrical heating (and also cooling) systems which take advantage of the relatively constant temperature of the soil during the whole year and can find an application in a wide range of buildings, all over the world. Geothermal sensors are heat exchangers (of the tubes), vertically (or horizontally) grounded, in which a thermally conducting fluid flows. During winter, the spaces are heated transferring the energy from the ground to the house, whereas during summer the system is reversed by drawing the heat from the environment and transferring it to the ground.

B.5 Tidal power and wave motion

The huge energy reserve offered by the sea (over 70% of the Earth surface is constituted by the ocean expanses with an average depth of 4000 m) is suitable to be exploited in different ways. In fact, in addition to the heat due to the thermal gradient (difference in temperature between two points), the sea has a kinetic energy due to the presence of currents, waves and tides.

Where there is a wide range between high and low tide it is possible to foresee the construction of a tidal stream energy power plant; on the coasts of Canada or on the English Channel coastline the difference in height (or head) between high and low tides reaches 8-15 m; on the contrary, in the Mediterranean Sea the tidal range does

not usually exceed 50 cm.

In a tidal power plant the water flows in and out of a basin of a few square kilometers, passing through a series of pipes in which it gains speed and drives some turbines connected to generators (alternators).

During the ebb tide the water flows from the basin to the deep sea, thus driving the turbine; when the sea level begins to rise and the tide is sufficiently high, the sea water is made to flow into the basin and the turbine is powered again.

A peculiarity of this system is the reversibility of the turbines which therefore can run both as the tide rises and as it falls (Figure B.1).

Figure B.1

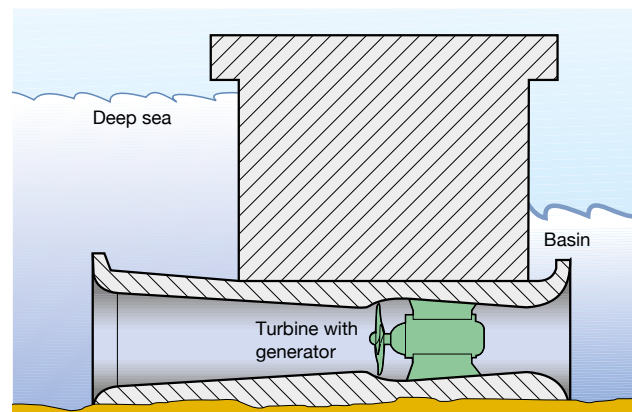

Generally speaking, the exploitation of tides to generate electricity is little effective; so far only two installations of this type have been built: the most important is on the estuary of the Rance River in Brittany (France) and has a total power capacity of 240 MW, the other one is in Russia.

The sea waves are a store of energy taken from the wind. The longer is the wavelength, the more energy can be stored. Given the expanse of the sea and the energy contained in a single wave, there is a huge reserve of renewable energy which can be used.

The average total amount of energy contained in the wave motion (travelling for hundreds of kilometers also without wind and with a little dispersion) offshore the coasts of the United States, calculated with a water depth of 60 m (the energy starts dissipating at about 200 m and at 20

² In Italy the exploitation of geothermal power is limited today to Tuscany and high Lazio with a total capacity of 681 MW in 2004, and a production of 5.4 billion kWh equal to 1.55% of the national electric production.

m depth it becomes a third), has been esteemed to be about 2.100 terawatt hour (TWh/year) (2100×10^{12} Wh). The production of tidal energy is already a reality which arouses a remarkable interest. In countries such as Portugal, United Kingdom, Denmark, Canada, USA, Australia, New Zealand, and others there are dozens of companies and research institutes exclusively involved in the matter. The cost per KWh, when using this resource, is already close to that of wind power generation.

The technologies under testing and those being used are different and numerous: floating devices anchored by means of a cable unrolled and wrapped up, piezoelectric pads, caissons filled with water and emptied, various floating systems and fixed systems both on the shore as well as on the sea floor.

The first installations were fixed structures with high environmental impact. The first floating project has been the project Kaimei in which a pool of nations (United States, United Kingdom, Ireland, Canada, and Japan) started in 1978 the construction of a ship whose power generation is 2 MWh. Another similar project is the Japanese Mighty Whale. The Italian project Sea Breath belongs to this family.

B.6 Mini-hydroelectric power

With the term mini-hydroelectric reference is usually made to hydroelectric generating stations with power lower than 10 MW, reduced dimensions and low environmental impact. The energy is obtained through hydraulic plants which utilize the water flow to drive the turbines. Mini-hydroelectric technology can represent an important resource for many agricultural and mountain areas, and can be exploited both by recovering the structures existing along the rivers (conduits, purification plants, aqueducts) as well as, in the presence of significant water flow, by forming water leaps and realizing interventions of limited impact on catchment basins.

B.7 Solar thermal power

Solar thermal plants are the most widespread ones and those which can more easily find an application in Italy on roofs. They use solar radiation, through a solar collector, mainly for water heating, for sanitary uses and after a careful evaluation also for the heating of rooms and swimming pools.

This technology is ripe and reliable, with installations having an average life of over 20 years and a payback period which can be very short. A family of 4 people using 75 liters of hot water per person/day, combining the

conventional gas boiler with a solar plant (typical plant: 4 m² panels and tank of 300 liters), can amortize the necessary investment, about 4,000 Euros, in a three-year period. This calculation takes into account the existing incentives which allow part of the purchase and installation costs to be deducted from the taxes (55% tax deduction for the energy requalification of the buildings).

The technological solutions currently available can be distinguished in three categories:

- *unglazed collectors*, based on a very simple operating principle: the water flows through pipes generally made of plastic material and directly exposed to solar radiation; by heating, the pipes make the temperature of the water circulating inside them rise;
- *flat plate collectors*, which are based on the same principle of the unglazed collectors, but use materials with higher thermal conductivity (copper, stainless steel, aluminium, ...) and are enclosed in cases (panels) constituted by a flat plate absorber on the rear part (aimed at retaining heat and maximizing radiation) and by a glass (or plastic material) plate in the upper part, in order to prevent the loss of heat in the environment through convection;
- *evacuated tube collectors*, in which the pipe containing the convector fluid is enclosed in a glass pipe with higher diameter and whose internal surface is coated with absorbing material and where vacuum is created to obtain thermal insulation to reduce heat loss due to convection.

The heat collected by the convector fluid is transferred to the sanitary water contained in a particular storage tank in different ways, according to the installation typology. The hot water produced by a solar thermal plant can be used:

1. for sanitary use (bathroom, cooking, washing machine, dishwasher)
2. to integrate space heating (better if combined with radiant systems such as radiant underfloor heating and wall panels because they require water at a lower temperature than normally used radiators, and cause less heat loss)
3. to maintain temperature in the swimming pools
4. both for families as well as in larger structures (leisure centers, hospitals, hotels, etc...).

By simplifying the classification, three alternative types of solar thermal plants can be identified:

- *natural circulation*. These are the systems which exploit the natural principle according to which a hotter fluid tends to rise, whereas a cooler fluid tends to move

downwards. In this case the thermal storage unit is positioned above the panel (mounted on the roof as in Figure B.2a or placed in the attic as in Figure B.2b). The thermo-vector fluid, once it has been heated by the solar radiation, rises directly in the storage unit and transfers its own heat to the water contained in it. Once the fluid has cooled it flows downwards into the panels and the cycle starts again. This technology simply needs some solar collectors and a storage unit/heat exchanger.

Surfaces and sizes vary according to the thermal requirements. The benefits of this type of plant are the cheapness, the possibility of functioning without electric pumps and control units, the inclination given by the slope of the roof, quick and economical installation, minimum maintenance and high efficiency strengthened by the natural circulation of the thermo-vector fluid. But there are also some disadvantages, from the slightest ones of aesthetic nature to the most important ones such as the exposure of the storage unit to atmospheric agents and to adverse environmental conditions and to the necessity that the roof is able to support the weight from a structural point of view.

Figura B.2

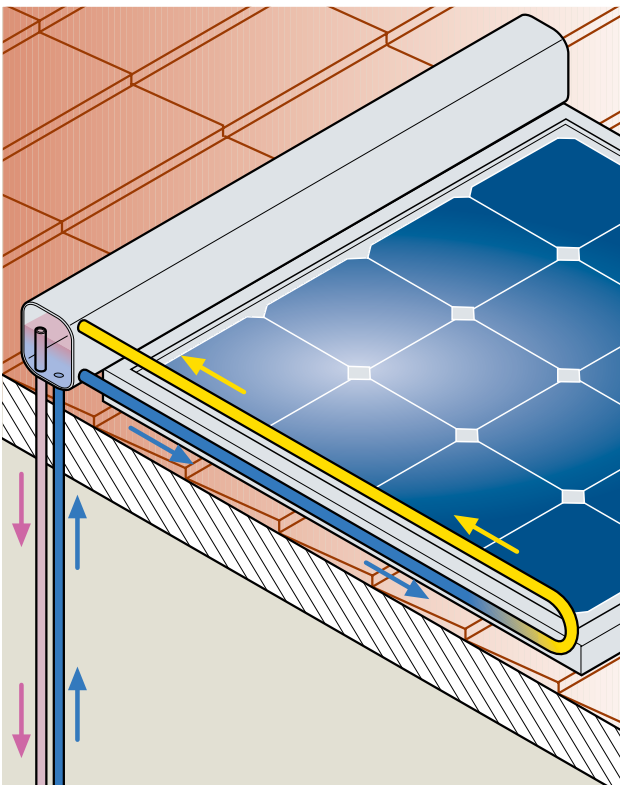

- **forced circulation.** Unlike natural convection, by forced circulation the storage unit can be positioned also at a lower level than the collectors and therefore inside the house too. In this type of installations, the presence of an electric pump allows the thermo-vector fluid to circulate from the collectors (higher position) to the thermal storage unit (lower).

With respect to natural circulation systems, this type of plant needs a circulation pump, a control unit, temperature sensors and expansion vessels, which usually implies higher costs and requires more maintenance. However, people who live in prestigious historic centers (and therefore in buildings subject to architectural constraints) and do not have an attic available to “hide” the storage unit of the natural circulation system, can solve the problem of the overall dimensions of the storage unit on the roof thanks to forced circulation (Figure B.3).

Figure B.3 - Scheme of a forced circulation plant

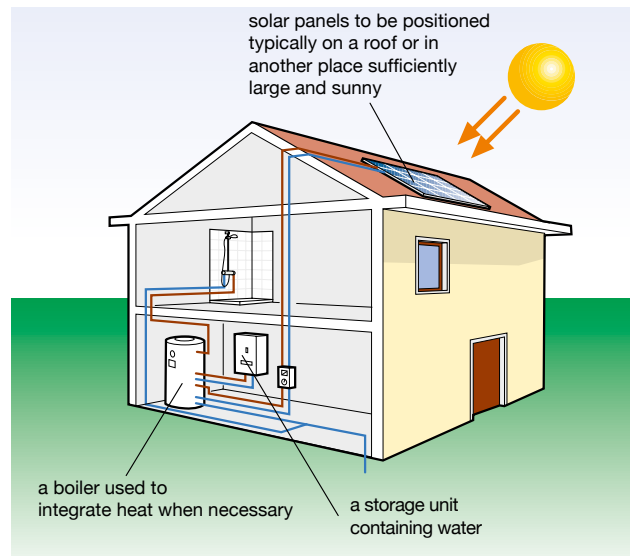

- **“drain back” forced circulation.** This technology represents an evolution of the traditional forced circulation and eliminates the possible inconvenience of stagnation of the thermo-vector fluid inside the collectors, which can happen when the pump is blocked or if other problems typical of forced circulation have occurred. “Stagnation” may cause overheating of the fluid with consequent serious damages to the solar plant. On the contrary, with this type of plant, when the pump stops, the modules empty and the liquid flows inside the drain storage unit thus preventing the collectors from breaking because of stagnation.

A 2-3 m² natural circulation plant with a 150/200 liter storage unit for hot sanitary water (able to satisfy the requirements of 2-4 people) has an average cost of 2,000-

3,000 €, installation, labor and VAT included. For a larger plant (4 m² of size) always with natural circulation, with 300 liter storage unit (useful to satisfy the requirements of 4-6 people), an indicative cost of about 4,000-4,500 € may be considered. A larger forced circulation plant - 15 m² with a 1,000 liter storage unit (for a 5 member family in a house with a floor heating system) contributing also to the heating of rooms - has an indicative cost of about 12,000 €. A solar thermal plant ensures savings on the electricity and/or on the gas bills, and favorable investment return times.

Solar modules satisfy about 70% of the requirements for sanitary hot water of a dwelling house. When using solar power also to integrate domestic heating, the total requirement which can be satisfied could reach up to 40%. A solar thermal system installed according to the state of the art may be guaranteed for fifteen years and with the proper maintenance it might also endure for a longer time.

For the solar thermal plants, only when installed in buildings already registered at the land-registry office, it is possible to obtain a fiscal exemption equal to 55% of the purchase and installation costs of the plant, to be divided into 5 years as established by the Law no. 2 dated 28th January 2009 converting the anti-crisis DL (Legislative Decree) 185/2008.

This deduction has been extended for further three years by the Financial Act 2008. The VAT for solar plants is 10%. Besides, in many regions, provinces and communes, incentives and loans are provided, which usually reach 25% to 30% of the total expenses.

B.8 Solar thermodynamic power

The conversion of solar energy into electricity is carried out in a solar thermodynamic plant in two phases:

- firstly solar radiation is converted into thermal energy;
- successively the thermal energy is converted into electrical power through a thermodynamic cycle.

The thermodynamic conversion of the second phase is completely analogous to what occurs in conventional thermal power stations and therefore it is necessary that the thermal power is available at high temperature to obtain high efficiency. As a consequence, in solar thermodynamic systems it is generally necessary to concentrate the solar radiation by means of a concentrator, constituted by suitably-designed mirrors to collect and focus the solar radiation onto a receiver which absorbs it and transforms it into thermal energy. The whole of concentrator and receiver forms the *solar collector*.

In the installation technologies currently available, the concentrator can be linear or point-focus, of continuous or discontinuous type (Figure B.4):

- solution a), parabolic trough collectors;
- solution b), parabolic dish concentrators;
- solution c), linear Fresnel reflectors;
- solution d), solar tower systems.

Figure B.4 – Typologies of solar collectors

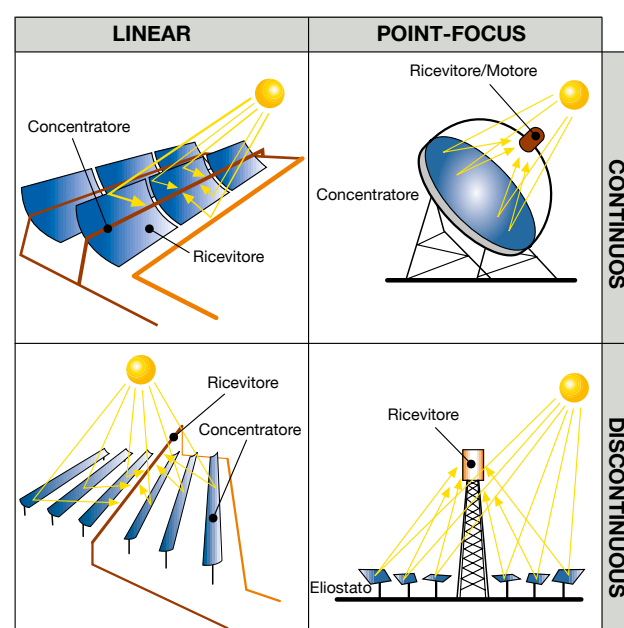

Every technology allows different concentration factors to be reached, i.e. different values of maximum temperature and with it the thermodynamic cycle typology most suitable for the conversion of thermal energy into electrical energy.

As a consequence, a solar thermal power station can be considered as the grouping of two sub-assemblies:

- one consisting of the solar collector which carries out the first phase of energy conversion;
- one converting the thermal energy into the electrical energy and which consists of the energy conversion equipment and of the transport and storage system which transfers heat from the collector to the thermodynamic cycle.

The thermal store unit has the purpose of storing the generated heat to ensure the proper operation of the plant in case of sudden variations in the irradiation due to weather phenomena.

According to the maximum temperature of the convector fluid, as thermodynamic cycle, the following typologies can be adopted: the water steam Rankine cycle (for temperatures in the range from 400° to 600°C) typical for plants with parabolic trough collectors, the Stirling cycle (for temperatures up to 800°C) in small parabolic dish plants and the Joule-Brayton cycle (for temperatures up to 1000°C), either in simple configuration or with combined cycle, typically in tower plants.

In the plants with *parabolic trough concentrators* (Figure B.5), the mirrors are used to focus the sunlight on thermal-efficient receiving tubes running along the focal line of the parabolic trough.

A heat-conducting fluid (synthetic oil or a mixture of molten salts) circulates through these tubes taking away the heat from the receiver and transferring it through heat exchangers to the water of the thermodynamic cycle, thus generating superheated steam to drive a standard steam turbine.

These types of plants have an average annual net conversion output of about 12 to 14% and constitute almost the totality of the existing thermodynamic solar plants.

Figure B.5 – Parabolic trough concentrators



In the plants with *parabolic dish concentrators* (Figure B.6), solar radiation is concentrated onto a collector positioned in the focus of a parabolic dish reflector. The collector absorbs the radiation heat and heats a fluid which is used to generate electrical energy directly in the receiver through a small Stirling engine or a small gas turbine.

These types of plants have an average annual net conversion output of about 18%, with daily peaks of 24%, but they are suitable for the generation of low powers (some dozens of kW).

Figure B.6 – Parabolic dish plant



The plants with *linear Fresnel concentrators* (Figure B.7) are conceptually similar to linear trough plants, have slightly lower optical returns but have simpler tracking systems for the mirrors and lighter structures since they are less exposed to wind.

They are still under test but, according to evaluations based on the manufacturing costs of the collectors, they result to be more profitable compared with other technologies

Figure B.7 – Linear Fresnel concentrator plant



In the *central receiver plants* (Figure B.8), the solar radiation coming from flat mirrors (heliostats) positioned on the ground in circles hits the central receiver mounted on a tower.

In the receiver there is an exchanger which absorbs the reflected radiation and converts it into thermal energy for the subsequent generation of superheated steam to be sent to the turbine or for the heating of either air or gas duly pressurized and used directly in open- or closed-cycle gas turbines.

Figure B.8 – Central receiver plant



according to the usage requirements; the second one is allowing the connection to a PV system, as a temporary replacement for the cogenerator, so that the panels can be exploited when insolation is at its maximum and the cogenerator in the night hours or with low irradiation.

The flexibility of DC cogeneration, applicable also to small users with an efficiency which can get to 90%, is well adapted to the intermittency of the renewable sources, thus allowing a constant supply also in stand-alone systems which do not turn to the grid for electric energy storage.

Besides, more complex hybrid systems are coming out: they allow the energy to be stored in the hydrogen produced by electrolysis using the electric energy generated in excess by photovoltaic or wind-powered systems when the consumption from the loads and the grid is low³.

The hydrogen produced is stored in tanks at high pressure and then used to generate electric energy through fuel cells or by biogas mixing⁴.

But these systems still have a low total efficiency in the conversion chain of electrical energy into hydrogen and then back into electricity through the fuel cells which are, moreover, expensive devices.

Yet there are some technical solutions aimed at reducing these disadvantages; their use on a big scale shall ensure a reduction in costs and an increase in the system integration with an ever wider spread, looking forward to the introduction of the Smart Grids, that is “smart distribution networks” able to shunt the electric power from one point of the grid to another in a scenario characterized by a variety of producers who, at the same time, are also self-consumers.

B.9 Hybrid systems

In the next future it will be possible to think not only of a renewable source applied to a building or a site, but hybrid solutions will be taken into consideration to allow a source to back up the other. Such integration has already found applications in residential buildings, where it is possible to find more and more thermal solar systems coupled with PV plants, or geothermal systems combined with solar thermal systems.

Moreover, nowadays, DC cogeneration is already present in the case of cogeneration plants producing heat and DC electrical energy which is converted into alternating current by an inverter analogously to the PV plants.

This type of plant offers two advantages: the first one is linked to the possibility of modulating the electric production from 15% to 100% of the maximum power

³ This is the typical case of wind-powered systems in northern Europe, where too much wind often blows in comparison with the real demands of the grid, and, as a consequence, wind turbines must be stopped, thus losing that production quota which could be used. In order to get round this, hydrogen-storage systems are being realized to store the energy produced by the wind blades in the windiest days, that is when the plants generate more energy than required by the grid.

⁴ Or heat generation for district heating and sale of any residual biogas as fuel for transport means.

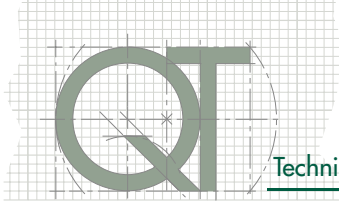

Annex C: Dimensioning examples of photovoltaic plants

C.1 Introduction

Here are two dimensioning examples of a photovoltaic power plant grid-connected in parallel to a preexisting user plant. The first example refers to a small grid-connected PV plant typical of a familiar end user, whereas the second one refers to a larger power plant to be installed in an artisan industry. In both cases the user plants are connected to the LV public utility network with earthing systems of TT type; the exposed conductive parts of the PV plants shall be connected to the already existing earthing system, but the live parts of the PV plant shall remain isolated.

Finally, the prospective short-circuit current delivered by the distribution network is assumed to be 6kA phase-to-neutral in the first example and 15kA three-phase in the second one.

C.2 3kWp PV plant

We wish to carry out the dimensioning of a PV plant for a detached house situated in the province of Bergamo; the plant shall be connected to the LV public utility network based on net metering. This house is already connected to the public network with 3kW contractual power and an average annual consumption of about 4000 kWh.

The side of the roof (gabled roof), into which the panels shall be partially integrated, has a surface of 60 m², is sloped with a tilt angle β of 30° and is +15° (Azimut angle γ) south oriented.

The power plant size decided is 3 kWp, so that the power demand of the user is satisfied as much as possible; with reference to the example 2.2 of Chapter 2, the expected production per year, considering an efficiency of the plant components of 0.75, is about 3430 kWh.

Choice of modules

By using polycrystalline silicon modules, with 175 W power per unit, 17 modules are needed, a value obtained by the relation $3000/175=17$. The modules are assumed to be all connected in series in a single string.

The main characteristics of the generic module declared by the manufacturer are:

• Rated power P_{MPP}^1	175 W
• Efficiency	12.8 %
• Voltage V_{MPP}	23.30 V
• Current I_{MPP}	7.54 A
• No-load voltage	29.40 V
• Short-circuit current I_{sc}	8.02 A
• Maximum voltage	1000 V

¹ MPP identifies the electrical quantities at their maximum power point under standard radiance conditions.

• Temperature coefficient P_{MPP}	-0.43%/°C
• Temperature coefficient U	-0.107 V/°C
• Dimensions	2000 x 680 x 50 mm
• Surface	1.36 m ²
• Insulation	class II

Therefore, the total surface covered by the modules shall be equal to $1.36 \times 17 \approx 23 \text{ m}^2$, which is smaller than the roof surface available for the installation.

By assuming -10°C and +70°C as minimum and maximum temperatures of the modules and by considering that the temperature relevant to the standard testing conditions is about 25°C, with the formula [2.13] the voltage variation of a PV module, in comparison with the standard conditions, can be obtained.

• Maximum no-load voltage	$29.40+0.107 \cdot (25+10) = 33.13\text{V}$
• Minimum voltage MPP	$23.30+0.107 \cdot (25-70) = 18.50\text{V}$
• Maximum voltage MPP	$23.30+0.107 \cdot (25+10) = 27.03\text{V}$

For safety purpose and as precautionary measures, for the choice of the plant components the higher value between the maximum no-load voltage and the 120% of the no-load voltage of the modules (note 7, Chapter 3) is assumed. In this specific case, the reference voltage results to be equal to $1.2 \cdot 29.40 = 35.28\text{V}$, since it is higher than 33.13V.

Electrical characteristics of the string:

• Voltage MPP	$17 \times 23.30 = 396 \text{ V}$
• Current MPP	7.54 A
• Maximum short-circuit current	$1.25 \times 8.02 = 10 \text{ A}$
• Maximum no-load voltage	$17 \times 35.28 = 599.76 \text{ V}$
• Minimum voltage MPP	$17 \times 18.50 = 314.58 \text{ V}$
• Maximum voltage MPP	$17 \times 27.03 = 459.50 \text{ V}$

Choice of the inverter

Due to the small power of the PV plant and to carry out the direct connection with the LV single-phase network, a single-phase inverter is chosen, which converts the direct current to alternating current thanks to the PWM control and IGBT bridge.

This inverter is equipped with an internal protection to prevent the inflow of currents with continuous components into the grid. It has input and output filters for the suppression of the emission disturbances - both conducted as well as radiated - and an isolation sensor to earth for the PV modules. It is equipped with the Maximum Power Point Tracker (MPPT) and with the interface device (DDI) with its relevant protection system (SPI).

Technical characteristics:

• Input rated power	3150 W
• Operating voltage MPPT on the DC side	203-600 V
• Maximum voltage on the DC side	680 V
• Maximum input current on the DC side	11.5 A
• Output rated power on the AC side	3000 W
• Rated voltage on the AC side	230 V
• Rated frequency	50 Hz
• Power factor	1
• Maximum efficiency	95.5%
• European efficiency	94.8%

To verify the correct connection string-inverter (see Chapter 3), first of all it is necessary to verify that the maximum no-load voltage at the ends of the string is lower than the maximum input voltage withstood by the inverter:

$$599.76 \text{ V} < 680 \text{ V (OK)}$$

In addition, the minimum voltage MPP of the string shall not to be lower than the minimum voltage of the inverter MPPT:

$$314.58 \text{ V} > 203 \text{ V (OK)}$$

whereas the maximum voltage MPP of the string shall not be higher than the maximum voltage of the inverter MPPT:

$$459.50 \text{ V} < 600 \text{ V (OK)}$$

Finally, the maximum short-circuit current of the string shall not exceed the maximum short-circuit current which the inverter can withstand on the input:

$$10 \text{ A} < 11.5 \text{ A (OK)}$$

Choice of cables

The modules are connected in series through the cables L1* and the string thus obtained is connected to the PV array combiner box immediately on the supply side of the inverter using solar single-core cables L2 with the following characteristics:

• cross-sectional area	2.5 mm ²
• rated voltage U ₀ /U	600/1000 VAC – 1500 VDC
• operating temperature	-40 +90 °C
• current carrying capacity in free air at 60°C (two adjacent cables)	35 A
• correction factor of the current carrying capacity at 70°C	0.91
• maximum temperature of the cable under overload conditions	120 °C

The current carrying capacity I_z of the solar cables installed in conduit at the operating temperature of 70°C results to be equal to (see Chapter 3):

$$I_z = 0.9 \cdot 0.91 \cdot I_0 = 0.9 \cdot 0.91 \cdot 35 \approx 29\text{A}$$

where 0.9 represents the correction factor for the installation of solar cables in conduit or in cable trunking. The carrying capacity exceeds the maximum short-circuit current of the string:

$$I_z > 1.25 \cdot I_{sc} = 10\text{A}$$

The frames of the modules and the supporting structure of the string are grounded through a cable N07V-K, yellow-green, 2.5 mm² cross-section. The connection between the PV array combiner box and the inverter is carried out using two single-core cables N07V-K (450/750V), 2.5 mm² cross-sectional area and L3=1m length, in conduit, with current carrying capacity of 24A, which is higher than the maximum string current.

The connections between the inverter and the contactor for the produced power (length L4=1m) and between the contactor and the main switchboard of the detached house (length L5=5m) are carried out using three single-core cables N07V-K (F+N+PE), 2.5 mm² cross-sectional area in conduit, with current carrying capacity of 21A, which is higher than the output rated current of the inverter on the AC side:

$$I_z > \frac{P_n}{V_n \cdot \cos\varphi_n} = \frac{3000}{230 \cdot 1} = 13\text{A}$$

Verification of the voltage drop

Here is the calculation of the voltage drop on the DC side of the inverter to verify that it does not exceed 2%, so that the loss of the produced energy is less than such percentage (see Chapter 3).

Length of the cables with 2.5 mm² cross-sectional area:

- connection between the string modules (L1):(17-1) x 1 m = 16 m
- connection between string and switchboard (L2): 15 m
- connection between switchboard and inverter (L3): 1 m
- total length 16 + 15 + 1 = 32 m

Therefore the percentage voltage drop results²:

$$\Delta U\% = \frac{P_{max} \cdot (\rho_1 \cdot L_1 + \rho_2 \cdot 2 \cdot L_2 + \rho_2 \cdot 2 \cdot L_3)}{s \cdot U^2} \cdot 100 = \leftarrow$$

$$\rightarrow \frac{3000 \cdot (0.021 \cdot 16 + 0.018 \cdot 2 \cdot 15 + 0.018 \cdot 2 \cdot 1)}{2.5 \cdot 396^2} \cdot 100 = 0.7\%$$

² The voltage drop between the inverter and the contactor of the generated power is ignored because of the limited length of the connection cables (1m). For the connection cables string-switchboard and switchboard-inverter, the resistivity of copper assumed at 30°C is 30°C ρ₂ = 0.018 $\frac{\Omega \cdot \text{mm}^2}{\text{m}}$, whereas, for the connection cables between modules, an ambient temperature of 70°C is considered; therefore ρ₁ = 0.018 · [1+0.004 · (70 - 30)] = 0.021 $\frac{\Omega \cdot \text{mm}^2}{\text{m}}$.

Switching and protection devices

With reference to the plant diagram shown in Figure C.1, the protection against overcurrent is not provided since on the DC side the cables have a current carrying capacity higher than the maximum short-circuit current which could affect them. In the main switchboard of the detached house, on the AC side, there is a thermomagnetic residual current circuit-breaker DS 201 C16 30mA/ typeA ($I_{cn} = 6kA$) for the protection of the connection line of the inverter against overcurrents and for the protection against indirect contacts. To guarantee the possibility of carrying out the necessary maintenance operations on the inverter, two switch-disconnectors are installed immediately upstream and downstream the inverter, S802 PV-M32 upstream and E202 $I_n=16A$ downstream respectively.

The protection against overvoltages is carried out on the

DC side by installing inside the PV array combiner box an SPD type OVR PV 40 600 P TS, upstream the switch-disconnector, for the simultaneous protection of both inverter and modules; on the AC side instead, an OVR T2 1N 40 275s P is mounted inside the input switchboard. The SPD type OVR PV installed on the DC side, shall be protected by two 4A fuses 10.3x38mm (or 16A, only with IP 65 enclosure) inserted in a switch-disconnector fuse holder E 92/32 PV. Instead, OVR T2 SPD, on the AC side, shall be protected by a fuse 10.3x38mm E9F 16A gG mounted on a fuse holder E91hN/32.

The other switching and protection devices, that is the input thermomagnetic circuit-breaker S202 C25, the main switch-disconnector E202 $I_n=25A$ and the two thermomagnetic residual current circuit-breakers DS201 C10/16, were already installed in the pre-existing user plant and are maintained.

Figure C.1

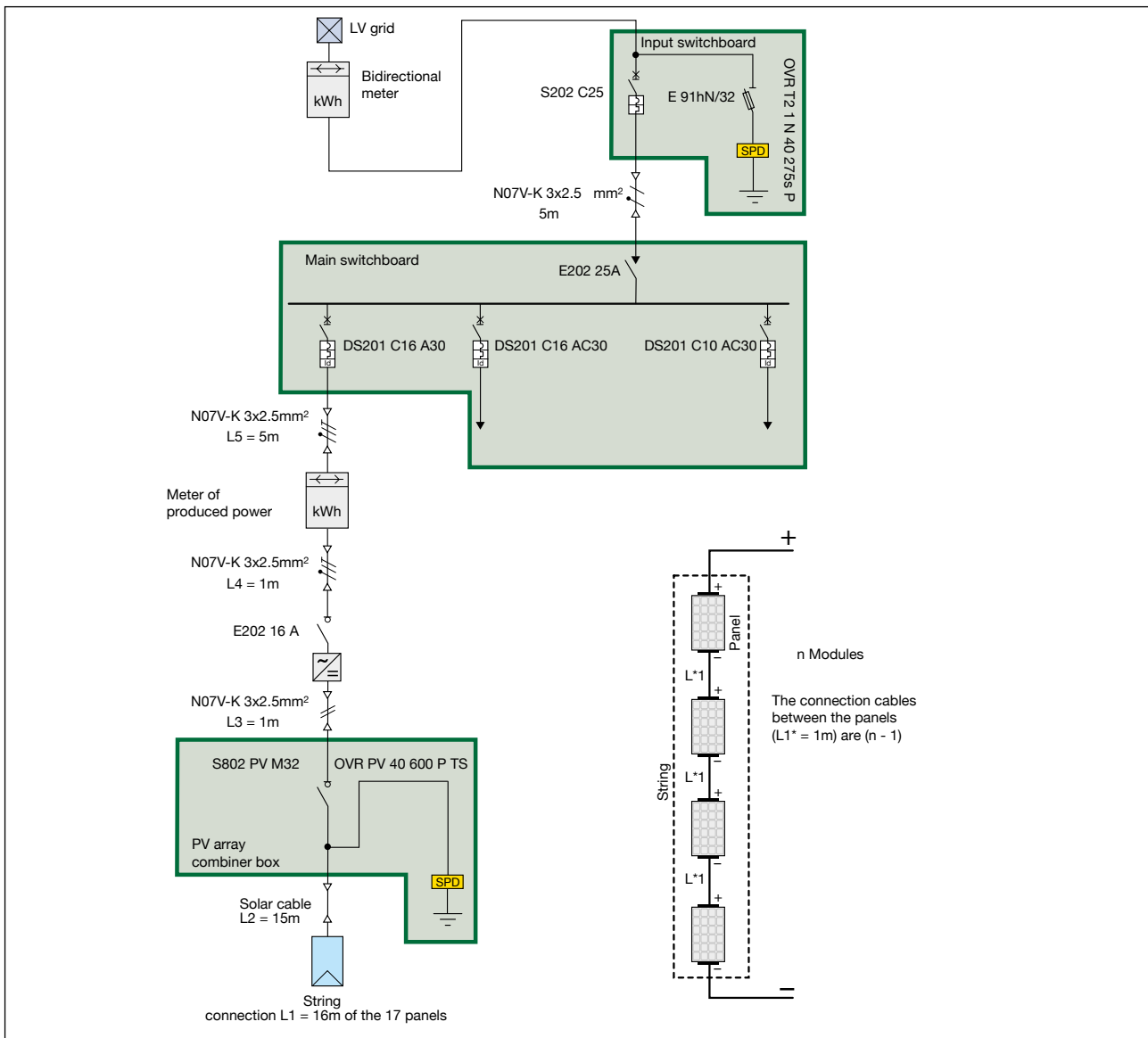

C.3 60kWp PV plant

We wish to carry out the dimensioning of a PV plant to be connected to the LV public utility network based on net metering for an artisan manufacturing industry situated in the province of Milan. This industry is already connected to the LV public network (400V three-phase) with 60 kW contractual power and an average annual consumption of about 70 MWh.

The side of the roof (Figure C.2) into which the modules shall be partially integrated has a surface of 500 m², is sloped with a tilt angle β of 15° and is -30° (Azimut angle γ) south oriented.

6kWp is the size decided for this power plant, based on net metering, so that the power demand of the user is satisfied as much as possible (as in the previous example). From Table 2.1 we derive the value of the solar radiation on a horizontal surface in Milan, which is estimated 1307 kWh/m². With the given tilt angle and orientation, a correction factor of 1.07 is derived from Table 2.3. Assuming an efficiency of the plant components equal to 0.8, the expected power production per year results:

$$E_p = 60 \cdot 1307 \cdot 1.07 \cdot 0.8 \approx 67 \text{ MWh}$$

Figure C.2

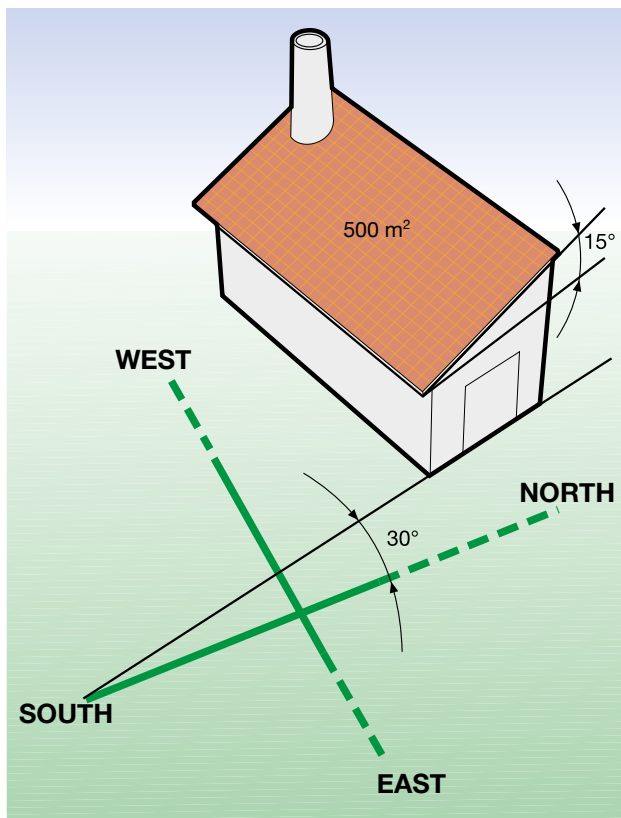

Choice of modules

By using polycrystalline silicon panels, with 225 W power per unit, 267 panels are needed, number obtained from the relation $60000/225=267$.

Taking into account the string voltage (which influences the input voltage of the inverter) and the total current of the strings in parallel (which influences above all the choice of the cables), we choose to group the panels in twelve strings of twenty-two modules each, for a total of $12 \cdot 22 = 264$ panels delivering a maximum total power of $264 \cdot 225 = 59.4$ kWp.

The main characteristics of the generic module declared by the manufacturer are:

• Rated power PMPP	225 W
• Efficiency	13.5 %
• Voltage VMPP	28.80 V
• Current IMPP	7.83 A
• No-load voltage	36.20 V
• Short-circuit current Isc	8.50 A
• Max voltage	1000 V
• Temperature coefficient PMPP	-0.48 %/°C
• Temperature coefficient U	-0.13 V/°C
• Dimensions	1680 x 990 x 50 mm
• Surface	1.66 m ²
• Insulation	class II

Therefore, the total surface covered by the modules shall be equal to $1.66 \times 264 = 438$ m², which is smaller than the roof surface available for the installation.

By assuming -10°C and +70°C as minimum and maximum temperatures of the modules and by considering that the temperature relevant to the standard testing conditions is about 25°C, with the formula [2.13] the voltage variation of a PV module, in comparison with the standard conditions, can be obtained.

• Maximum no-load voltage	$36.20 + 0.13 \cdot (25 + 10) = 40.75\text{V}$
• Minimum voltage MPP	$28.80 + 0.13 \cdot (25 - 70) = 22.95\text{V}$
• Maximum voltage MPP	$28.80 + 0.13 \cdot (25 + 10) = 33.35\text{V}$

For the choice of the plant components, for safety purpose and as a precautionary measure, the higher value between the maximum no-load voltage and the 120% of the no-load voltage of the modules (note 7, Chapter 3) is considered. In this specific case, the reference voltage results to be equal to $1.2 \cdot 36.20 = 43.44\text{V}$, since it exceeds 40.75V.

Electrical characteristics of the string:

• Voltage MPP	$22 \times 28.80 = 663.6\text{ V}$
• Current MPP	7.83 A
• Maximum short-circuit current	$1.25 \times 8.50 = 10.63\text{ A}$
• Maximum no-load voltage	$22 \times 43.44 = 955.68\text{ V}$
• Minimum voltage MPP	$22 \times 22.95 = 504.90\text{ V}$
• Maximum voltage MPP	$22 \times 33.35 = 733.70\text{ V}$

Choice of the inverter

Two three-phase inverters are chosen, each with 31kW input rated power; therefore six strings in parallel shall be connected to each inverter.

The three-phase inverters which have been chosen convert direct current to alternating current thanks to the PWM control and IGBT bridge.

They have input and output filters for the suppression of the emission disturbances, both conducted as well as radiated, and an earth-isolation sensor for the PV modules. They are equipped with the Maximum Power Point Tracker (MPPT) and have an internal protection preventing the inflow of currents with continuous components into the grid.

Technical characteristics:

- Input rated power 31000 W
- Operating voltage of the inverter MPPT on the DC side 420-800 V
- Maximum voltage on the DC side 1000 V
- Maximum input current on the DC side 80 A
- Output rated power on the AC side 30000 W
- Rated voltage on the AC side 400 V three-phase
- Rated frequency 50 Hz
- Power factor 0.99
- Maximum efficiency 97.5%
- European efficiency 97%

To verify the correct connection string-inverter (see Chapter 3) first of all it is necessary to verify that the maximum no-load voltage at the ends of the string is less than the maximum input voltage withstood by the inverter:

$$955.68 \text{ V} < 1000 \text{ V (OK)}$$

In addition, the minimum voltage MPP of the string shall not be lower than the minimum voltage of the inverter MPPT:

$$504.90 \text{ V} > 420 \text{ V (OK)}$$

whereas the maximum voltage MPP of the string shall not exceeds the maximum voltage of the inverter MPPT:

$$733.70 \text{ V} < 800 \text{ V (OK)}$$

Finally, the maximum total short-circuit current of the six strings connected in parallel and relevant to each inverter shall not exceed the input maximum short-circuit current which the inverter can withstand:

$$6 \times 10.63 = 63.75 \text{ A} < 80 \text{ A (OK)}$$

Choice of cables

The modules are connected in series using the cable L1* and each deriving string is connected to the PV array combiner box inside the shed and upstream the inverter through solar cables with length L2, positioned in two cable trunkings, containing 6 circuits in bunches each. Here are the characteristics of the solar cables:

- cross-sectional area 4 mm²
- rated voltage U₀/U 600/1000 VAC – 1500 VDC
- operating temperature -40 +90 °C
- current carrying capacity in free air at 60°C 55 A
- correction factor of the carrying capacity at 70°C 0.91
- maximum temperature of the cable under overload conditions 120 °C

The current carrying capacity I_z of the solar cables bunched in conduit at the operating temperature of 70°C results to be equal to (see Chapter 3):

$$I_z = 0.57 \cdot 0.9 \cdot 0.91 \cdot I_0 = 0.57 \cdot 0.9 \cdot 0.91 \cdot 55 \approx 26\text{A}$$

where 0.9 represents the correction factor for the installation of the solar cables in conduit or in cable trunking, whereas 0.57 is the correction factor for 6 circuits in bunches.

The carrying capacity is higher than the maximum short-circuit current of the string:

$$I_z > 1.25 \cdot I_{sc} = 10.63\text{A}$$

The frames of the modules and the supporting structure of each string are earthed through a cable N07V-K, yellow-green, with 4 mm² cross-section. With reference to the electric diagram of Figure C.2, the connection of the PV array combiner box to the inverter is carried out by using two single-core cables N1VV-K (0.6/1kV sheathed cables) with 16 mm² cross-section and length L3=1m in conduit, current carrying capacity of 76A, a value exceeding the maximum total short-circuit current of the six strings connected in parallel:

$$I_z > 6 \cdot 1.25 \cdot I_{sc} = 63.75\text{A}$$

The connection between the inverter and the paralleling switchboard of the inverters is carried out using three single-core cables N1VV-K of 16 mm² cross-section and length L4=1m in conduit, current carrying capacity of 69A, which is higher than the output rated current of the three-phase inverter:

$$I_z > \frac{P_n}{\sqrt{3} \cdot V_n \cdot \cos\varphi_n} = \frac{30000}{\sqrt{3} \cdot 400 \cdot 0.99} = 43.7\text{A}$$

The connections between inverter paralleling switchboard and contactor of the produced power (length $L_5=3\text{m}$), and between contactor and main switchboard of the industry (length $L_6=7\text{m}$) are carried out using three single-core cables N1VV-K with 35 mm^2 cross-sectional area in conduit, with current carrying capacity of 110A, which is higher than the output rated current of the PV plant:

$$I_z > \frac{P_n}{\sqrt{3} \cdot V_n \cdot \cos\varphi_n} = \frac{60000}{\sqrt{3} \cdot 400 \cdot 0.99} = 87.5\text{A}$$

The protective conductor PE is realized using a yellow-green single-core cable N07V-K and 16 mm^2 cross-sectional area.

Figure C.3

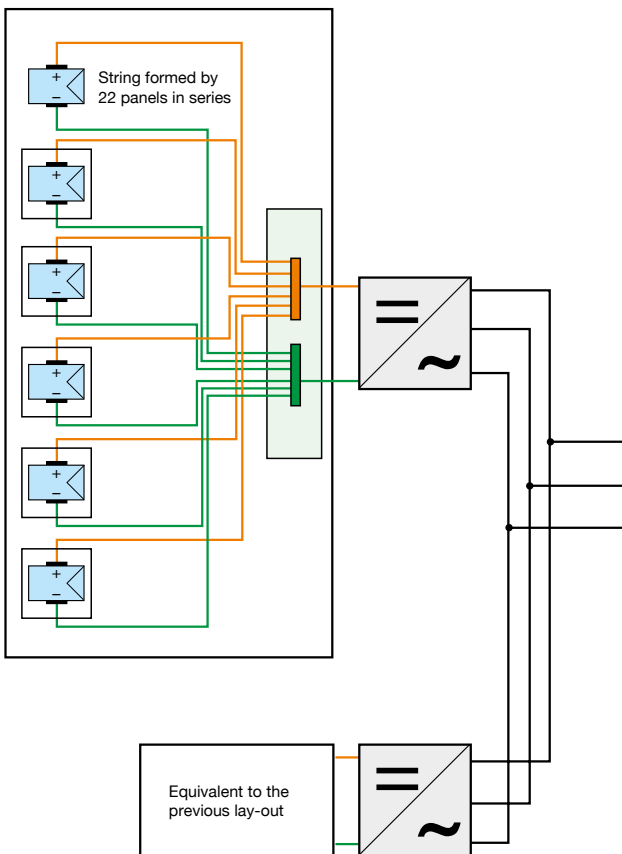

Verification of the voltage drop

Here is the calculation of the voltage drop on the DC side of the inverter to verify that it does not exceed 2% (see Chapter 3).

Length of the cables with 4 mm^2 cross-section, DC side:

- connection between the string modules (L_1^*): $(22-1) \times 1\text{ m} = 21\text{ m}$
- connection between string and switchboard (L_2): 20 m

Length of the cables with 16 mm^2 cross-section, DC side

- connection between switchboard and inverter (L_3): 1 m

Total length of the cables on the DC side: $21 + 20 + 1 = 42\text{ m}$

The average percentage of voltage drop up to the PV array combiner box, when the panels constituting the string deliver the maximum power $P_{\max} = 22 \times 225 = 4950\text{W}$, with string voltage of 663.6V results to be³:

$$\Delta U\% = \frac{P_{\max} \cdot (\rho_1 \cdot L_1 + \rho_2 \cdot 2 \cdot L_2)}{s \cdot U^2} \cdot 100 = \downarrow$$

$$\rightarrow \frac{4950 \cdot (0.021 \cdot 21 + 0.018 \cdot 2 \cdot 20)}{4 \cdot 663.6^2} \cdot 100 = 0.326\%$$

The average percentage of voltage drop between the PV array combiner box and the inverter with $P_{\max} = 6 \times 4950 = 29700\text{W}$ results to be:

$$\Delta U\% = \frac{P_{\max} \cdot (\rho_2 \cdot 2 \cdot L_3)}{s \cdot U^2} \cdot 100 = \frac{29700 \cdot (0.018 \cdot 2 \cdot 1)}{16 \cdot 663.6^2} \cdot 100 = 0.015\%$$

Therefore, the total voltage drop results equal to 0.34%.

Switching and protection devices

PV array combiner boxes

The current carrying capacity of the string cables is higher than the maximum current which can pass through them under standard operating conditions; therefore it is not necessary to protect them against overload.

³ For the connection cables string-switchboard and switchboard-inverter the resistivity of copper at 30°C $\rho_2 = 0.018 \frac{\Omega \cdot \text{mm}^2}{\text{m}}$, is assumed, whereas for the connection cables between panels an ambient temperature of 70°C is assumed; then $\rho_1 = 0.018 \cdot [1 + 0.004 \cdot (70 - 30)] = 0.021 \frac{\Omega \cdot \text{mm}^2}{\text{m}}$.

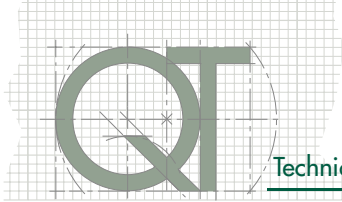

Under short-circuit conditions, the maximum current in the string cable affected by the fault results (see clause 4.1.4):

$$I_{sc2} = (S_A - 1) \cdot 1.25 \cdot I_{sc} = (6 - 1) \cdot 1.25 \cdot 8.50 \approx 53A$$

this value is higher than the cable carrying capacity: as a consequence, it is necessary to protect the cable against short-circuit by means of a protective device, which under fault conditions shall let through the power that the cable can withstand.

With reference to the diagram of Figure C.2, the six protection devices in the PV array combiner box shall have a rated current (see relation [4.1]) equal to:

$$1.5 \cdot I_{sc} \leq I_n \leq 2.4 \cdot I_{sc} \rightarrow 1.5 \cdot 8.5 \leq I_n \leq 2.4 \cdot 8.5 \rightarrow I_n = 16A$$

Therefore, a S804 PV-S16 is chosen, which has a rated voltage $U_e=1200VDC$ and a breaking capacity $I_{cu}=5kA > I_{cc2}$.

The connection cables between PV array combiner box and inverter do not need to be protected against overcurrents since their current carrying capacity is higher than the maximum current which may interest them. Therefore, a main switch-disconnector circuit-breaker XT1D PV 160⁴ shall be mounted inside the PV array combiner box to disconnect the inverter on the DC side.

In the PV array combiner boxes also some surge suppressors (SPD) shall be installed for the protection of the inverter on the DC side and of the PV modules: the choice is SPD type OVR PV 40 1000 P TS protected by 4A fuses gR (or 16A fuses only in case of IP65 enclosures) mounted on fuse holders type E92/32 PV.

Inverter paralleling switchboard

With reference to the plant diagram of Figure C.4, on each of the two lines coming from the three-phase inverters, a generator themomagnetic circuit-breaker S203 P - C63⁵ (having a breaking capacity equal to the prospective three-phase short-circuit current given by the network) is installed, coupled with a residual current device type DDA 203 A - 63/0.03 ($I_{dn}=30mA$ type A). A switchboard switch disconnector XT1D 160 3p is also installed.

Main switchboard

In the main switchboard of the industry, where the main circuit-breaker and the protective devices for the distribution lines of the user's plant are already present, a circuit-breaker SACE Tmax XT2N 160 Ekip LS/I $I_n=100A$ is installed, which has the function of interface device (DDI) and to which the interface protection system (SPI) CM-UFD.M32 is associated.

The circuit-breaker XT2 is installed also with the purpose of protecting against the overcurrents the switch-disconnector in the paralleling switchboard and the cables for the connection between the paralleling switchboard and the main switchboard.

For the protection of the plant against the input overvoltages on the network side, a surge suppressor type OVR T2 3L 70 275s P TS is installed, protected by E 9F10 GG20 fuses mounted on E93hN/32 fuse holders.

⁴ Two poles in series are connected with the positive polarity and two in series on the negative polarity since the PV system is isolated from earth

⁵ The neutral pole is not connected.

Figure C.4

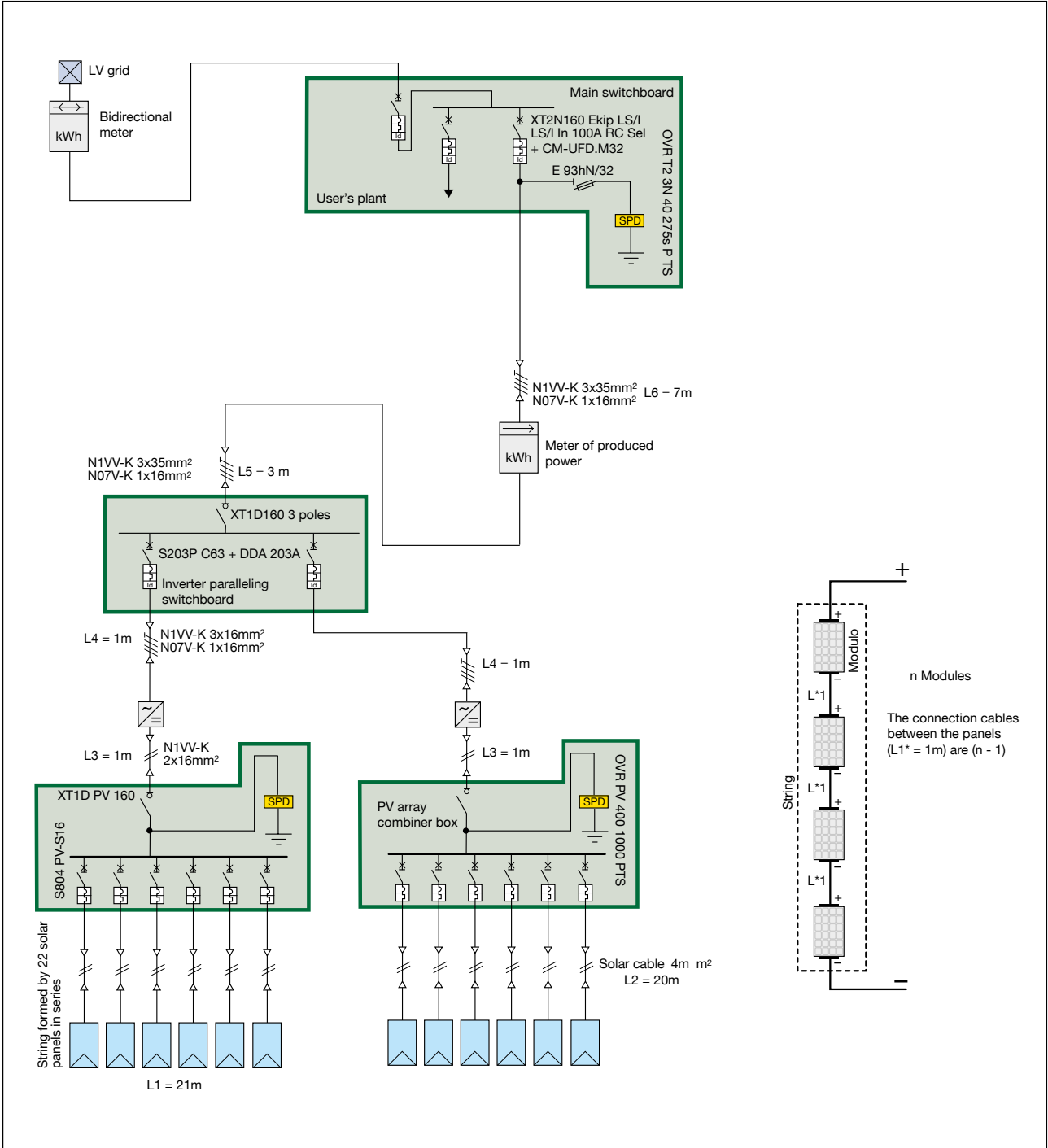

Annex D: Temperature rise, MCB and disconnect behavior in photovoltaic applications

Assembly engineering in the PV industry differs in different aspects to well-known AC switchgear assembly. This annex provides useful wiring advices to take in consideration when designing PV panels and especially the PV breakers and disconnectors:

There is no Simultaneity Factor for PV applications

Depending on the national installation rules, assembly engineering takes into consideration that not all AC consumers are active at the same time.

By applying a simultaneity factor, upstream MCBs' rated currents are less than the sum of the downstream circuit breakers.

However, in PV applications, all strings produce the same solar power leading to a simultaneity factor of 1.

Ambient Temperature

The PV industry requires low voltage products operable in a large temperature range. Inverters and combiners can become very cold at night and very warm during daytime with a typical peak reached in the early afternoon.

Therefore, PV breakers and disconnectors can be used not only in the temperature range given by the standards but also at temperatures down to -40°C and up till 70°C with regard to a certain uprating or derating factor.

It's important to keep in mind that ambient temperature always refers to PV breakers or disconnectors, not the air temperature outside the combiner or inverter.

The power loss as a result of internal contact resistance of PV breakers and disconnectors cabling connection and surrounding low voltage products lead to an internal heating of the enclosure. This fact must be considered when choosing the right enclosure size.

Combiner boxes should preferably be placed at locations where direct sun exposure is prohibited.

Low environmental temperature usually increases the lifetime of components and the reliability of the application. A box directly put in the sun, can easily have an inside air temperature increase of 30 K.

Under worst case conditions, (maximum environment temperature, maximum load, direct sunlight exposure, etc.) the internal box temperature can easily exceed 100°C .

In a typical combiner containing a PV disconnecter, 24 fuses for string protections (12 strings), connectors and cables, the total internal resistance of cables and components can be estimated at 0.01 ohm, which would result in a total dissipation of 100 W at 100 A DC load. 100 Watt dissipation in a hermetically closed enclosure will definitely lead to a significant increase of the temperature inside the enclosure.

The temperature might even exceed the temperature specifications of components inside the box.

Therefore enclosure dimensions are a very important design issue.

It should also be noticed that temperature increase usually correlates with the load current square (I^2). E.g. if a 100 A DC load would give a temperature rise of 30 K, 125 A DC would probably result in a temperature increase of 45 K.

T_{in} = inside temperature
(= ambient temperature of products)

Terminal temperature

T_a = Ambient temperature

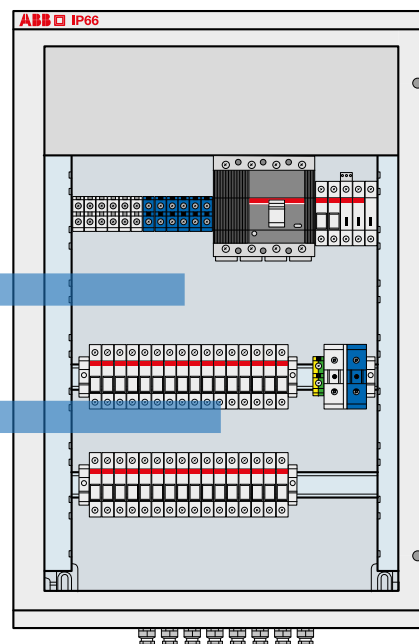

Pole Connection

When using three and four pole PV breakers or disconnectors, the poles must be wired in series in compliance with the assembly standards. Best practice has shown that the following variables must be considered:

- Jumper diameter (pole connector) has to comply with the cable diameter to meet the requirements of the assembly standards.
- Jumper length: Jumper length must be sufficient for PV breaker or disconnector heat dissipation as jumpers work as heat sinks. In addition, it is important to check the cable manufacturers' minimum bending radius data. Over-bending cables might affect the long term cable insulation.
- Jumper insulation: Photovoltaic cables often have extra insulation. This might lead to low heat radiation.
- Tightening torque: it is necessary to respect mounting instruction for the correct terminal tightening torque value. If the tightening torque is not as specified by the manufacturer it will definitely lead to an increase of the electrical impedance, but also the thermal resistance will go up. On the long run, this might result in reliability problems or overheating.
- Jumpers or equivalent busbars from different manufacturer than the PV breakers or disconnectors manufacturer may not be approved.

Enclosure Dimensioning

Against the background given above, dimensioning a PV enclosure differs from the dimensioning of a typical AC enclosure. The following variables affect the heating performance of an equipped PV enclosure.

- IP class: The tighter the enclosure, the worse the heat dissipation. For this reason, state-of-the-art inverters and combiners are equipped with heat exchangers or ventilation.
- Transparent covers: Transparent enclosure covers are reported to influence the inside temperature by 40K within just a few minutes of direct solar radiation. In addition, not every transparent cover is 100% UV resistant.
- Ground plate material: Metallic ground plates are reported to have positive effect on enclosure heat management.
- DIN rail size: Industrial DIN-Rails (15mm or higher) have a positive effect on low voltage product heat dissipation as they increase air space between the ground plate and the low voltage products.
- Dimensions (volume) in general.

PV breakers and disconnectors Mounting Distances

Due to the temperature related derating values of PV breakers and disconnectors, a distance between adjacent breakers or disconnector should be considered with regard to the other variables in this context.

Recommendation

It is strongly recommended to perform temperature tests on enclosure under maximum application conditions to verify the appropriate design of the enclosure. In addition, it is necessary to make sure that national and international installation standards are fulfilled.

Standards

The installation of switches, switch-disconnectors and breaker shall comply with national and /or international standards.

For the erection of panel boards these standards usually refer to IEC 61439-1 and IEC 61439-2 (Low-voltage switchgear and controlgear assemblies - Part 1: General rules / - Part 2: Power switchgear and controlgear assemblies).

In these standards the requirements for cable dimensions, environmental conditions like max. allowed temperature, etc. are specified.

The applicant must make sure that the installation is compliant with these relevant standards e.g. IEC 61439-1 and IEC 61439-2.

Additional Information: Temperature Related First Aid

If an enclosure has not been assembled with regard to the special features described above, the following first aid advice might be helpful:

- Mounting of PV breakers or disconnectors in vertical position has a positive derating effect.
- Terminal tightening torque according to the mounting instructions optimizes the contact resistance between cable and terminal.
- When available, the use of ring lug kits PV breakers and disconnectors usually allow the mounting of bigger cable diameters. This can have a positive effect on temperature related nuisance tripping.

Technical Application Papers

QT1

Low voltage selectivity with ABB circuit-breakers

QT7

Three-phase asynchronous motors
Generalities and ABB proposals for the coordination of protective devices

QT2

MV/LV transformer substations: theory and examples of short-circuit calculation

QT8

Power factor correction and harmonic filtering in electrical plants

QT3

Distribution systems and protection against indirect contact and earth fault

QT9

Bus communication with ABB circuit-breakers

QT4

ABB circuit-breakers inside LV switchboards

QT10

Photovoltaic plants

QT5

ABB circuit-breakers for direct current applications

QT11

Guidelines to the construction of a low-voltage assembly complying with the Standards IEC 61439 Part 1 and Part 2

QT6

Arc-proof low voltage switchgear and controlgear assemblies

QT12

Generalities on naval systems and installations on board

QT13

Wind power plants

Contact us

ABB SACE

A division of ABB S.p.A.

L.V. Breakers

Via Baioni, 35

24123 Bergamo - Italy

Tel.: +39 035 395 111

Fax: +39 035 395306-433

www.abb.com/solar

The data and illustrations are not binding. We reserve the right to modify the contents of this document on the basis of technical development of the products, without prior notice.

Copyright 2014 ABB. All rights reserved.